

RASENTRAKTOREN  
LAWN TRACTORS  
Tracteurs de pelouse

Inhaltsverzeichnis  
Table of contents  
Tables de matières





Modelle 2007

**Crossover**

**92 / 13 Hydro**

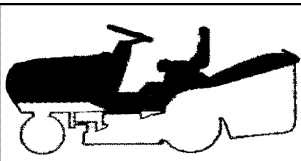
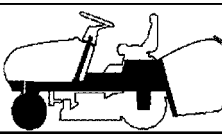
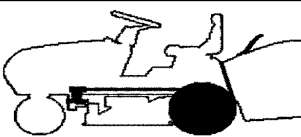
Art. 65056

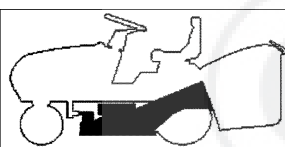
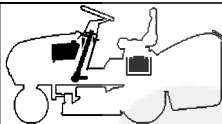
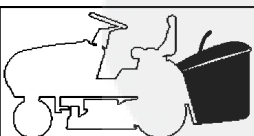
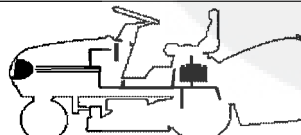
1		KARROSSERIE BODY CARROSSERIE
2		RAHMENSATZ & LENKGETRIEBE CHASSIS & STEERING CHASSIS & BARRE DE DIRECTION
3		GETRIEBE TRANSMISSION TRANSMISSION
4		MOTOR ENGINE MOTEUR
5		SCHNEIDWERK CUTTING PLATE PLATEAU DE COUPE
6		TANK, BATTERIE & KOMPONENTEN TANK, BATTERY & COMPONENTS TANK, BATTERIE & COMPOSANTS
7		GRASFANGSACK KPL. GRASS CATCHER ASSY. BAC COMPOSANTS
8		ELEKTRIK 1 ELECTRIC 1 ELECTRIQUES 1



2/22		RASENTRAKTOREN		Crossover	
2007		LAWN TRACTORS		92 / 13 Hydro - Art. 65056	
Rev070601		Tracteurs de pelouse		Modell 2007	
Bild Nr. REF.N° POS.N°	BEST.-NR. PART.-N° N° d. PIECE	BEZEICHNUNG	DESCRIPTION	DÉSIGNATION	Qty.
1	A348947	SCHRAUBE PT-KB 60X20 1442	SCREW	ECROU	2
2	A461117	LENKRAD KPL	STEERING WHEEL	VOLANT	1
3	A46111801	ABDECKKAPPE FÜR LENKRAD R9005	STEERING CAP	BOUCHON	1
4	A46176247	ABDECKUNG, UNTEN	LOWER COVER PLATE	COUVRE	1
5	A46176301	TRITTPLATTE RECHTS R9005	RIGHT FOOTBOARD	COUVRE MARCHEPIED DROITE	1
6	A46177401	ABDECKUNG SCHALTKULISSE FUSSC R9005	BEZEL	BANDEAU	1
7	A46273176	OBERTEIL HAUBE OEM-BRILL R7016	UPPER HOOD R7016	CAPOT R7016	1
8	A510177	SHR PT-KB 60 X14 1411	SCREW KB 60 X14 1411	VIS KB 60 X14 1411	2
9	A51400247	KONSOLE MOTORHAUBE R6001	CENTRAL DASHBOARD	SUPPORT TABLEAU CENTR.	1
10	A51400547	MITTELKONSOLE HINTEN R6001	REAR COVER	COUVRE	1
11	A51414801	ABDECKUNG HÖHENVERSTELLUNG R9005	BEZEL R9005	BANDEAU R9005	1
12	A514166	SITZ 1	SEAT	SIÈGE	1
13	A514251	LAMPE XENON 6W	FARILAMP XENON 6W	LAMPE XENON 6W	2
14	A514252	LAMPENFASSUNG TRAKTOR	LAMP HOLDER	DOUILLE DE LAMPE	2
16	A514316	SCHRAUBE SFS-TAPT 6X12 2019 A3R	SCREW	VIS	6
17	A514317	SCHRAUBE SFS.TAPT6X16 2019 A3R	SCREW	ECROU	3
18	A514331	BLECHMUTTER 4.8 FORM 1 VZ	NUT	ECROU	7
19	A514419	FEDERSTAHL DRAHT VERZ	ROD	BARRE	1
20	A514544	SCHRAUBE PT-KB60X30 1411A3R	SCREW	ECROU	4
21	A514879	SCHALTER JXA2Z00B-AZC00-000-XA	SWITCH	BOUTON	1
22	A51496401	TRITTPLATTE LINKS 102 R9005	LEFT FOOTBOARD	COUVRE MARCHEPIED GAU.	1
23	A521084	BEDIENKONSOLE TAMP Y-SILBER	DASHBOARD TAMP Y-SILBER	TABLEAU DE BORD TAMP Y-SILBER	1
24	A521460	SCHARNIERBLECH HAUBE	HOOD SUPPORT	CAPOT SUPPORT	1
25	A521554	SCHEINWERFER KPL HAUBE-4 XENON 6W	FLOOD LIGHT CARTRIDGE ASSY.	PHARE GARNITURE CPL.	1
26	A52157347	FRONTTEIL HAUBE R6001	FRONT HOOD GREEN	CAPOT VERT	1
27	A52157547	SEITENTEIL RECHTS HAUBE R6001	SIDE HOOD RIGHT	CAPOT DROITE	1
28	A52157647	SEITENTEIL LINKS HAUBE R6001	SIDE HOOD LEFT	CAPOT GAUCHE	1
29	A52157876	FRONTBLLENDE	COVER PLATE	GRILL	1
30	A521606	SCHLAUCHKLEMME "REFLEKTOR"	FAIR LED	FIXATION	2
31	A521676	SCHNAPPMUTTER NU 0921	NUT NU 0921	ECROU NU 0921	6
32	A521679	SCHRAUBE PT-KB 30X12 WN 5452	SCREW	VIS	2
33	A700148	SCHEIBE 6,4 9021-ST VZ	WASHER	RONDELLE	1
34	A700664	SPANNHUELSE 8 X 60 1481	COLLET	DOUILLE	1
35	A703005	SCHEIBE 6,4 9021-ST A3S	WASHER	RONDELLE	11
36	A704325	SCHRAUBE 6X 40 933- 8.8A3S	SCREW	VIS	6
37	A704536	MUTTER 6KT 6 985- 8 A3B	NUT	ECROU	2
38	A704752	SCHRAUBE KO 4,8X16 ZZ-C7981VZ	SCREW	ECROU	13





KARROSSERIE  
BODY  
CARROSSERIE



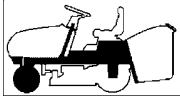

4/22		RASENTRAKTOREN		 RAHMENSATZ & LENKGETRIEBE CHASSIS & STEERING CHASSIS & BARRE DE DIRECTION		Crossover		92 / 13 Hydro - Art. 65056 Modell 2007		1/3		 	
2007		LAWN TRACTORS				92 / 13 Hydro - Art. 65056 Modell 2007							
Rev070601		Tracteurs de pelouse											
Bild Nr. REF.N° POS.N°	BEST.-NR. PART-N° N° d. PIECE	BEZEICHNUNG	DESCRIPTION	DÉSIGNATION	Qty.								
1	A2042850001	DRUCKKNOPF F. BR-HEBEL T	BUTTON	POUSSOIR	1								
2	A2045480006	FEDER F. HANDGRIFF T	SPRING	RESSORT	1								
3	A302231	KAPPE R9005	CAP	BONNET	1								
4	A348988	MUTTER SIC- BIW M 8 A3C- 8 MITTELGESICH	NUT	ECROU	1								
5	A375725	HANDGRIFF HOENENVERST. T	KNOB	POIGNEE	1								
6	A450263	BUCHSE TRAKTOR VORDERRAD	BUSH	DOUILLE	2								
7	A46110530	LENKSEGMENT GESCHW VERZ	SEGMENT	SEGMENT GUIDER	1								
8	A46110730	LENKHEBEL 2 TEILIG UNTEN VERZ	LOWER STEERING ARM	LEVIER GUIDER EN BAS	1								
9	A46110830	LENKHEBEL 2 TEILIG OBEN VERZ	UPPER STEERING ARM	LEVIER GUIDER EN HAUT	1								
10	A461109	BUNDBUCHSE LENKUNG	COLLAR BUSH	DOUILLE	1								
11	A461110	BUCHSE	BUSH	DOILLE	1								
12	A46111130	SCHUBSTANGE VERZ	STEERING ROD DIRECTION	LEVIER BARRE DE	1								
13	A461231	MUTTER SIC- BIW M10 A3B- 8	NUT	ECROU	2								
14	A461289	ABDECKKAPPE"TRAKTOR"	HUB COVER	COUVRE MOYEU	2								
15	A461290	SCHEIBE 42MM FÜR TRAKTOR	WASHER	RONDELLE	2								
16	A461497	WIPPE FÜR KUPPLUNG FAHRANTRIEB	ROCKER	BASCULE	1								
17	A461498	ZUGSTANGE FÜR KUPPLUNG FAHRANTRIEB	TENSION ROD	BARRE	1								
18	A461499	ROHR FÜR KUPPLUNG FAHRANTRIEB	TUBE FOR CLUTCH (DRIVE)	TUYAU EMBRAYAGE ENTR.D.ROUE	1								
19	A461500	ZUGFEDER FÜR KUPPLUNG FAHRANTRIEB	SPRING	RESSORT	1								
20	A461502	KUGELFÜHRUNG FÜR KUPPLUNG FAHRANTR	GUIDANCE	GUIDAGE	3								
21	A461535	MANTEL FÜR REIFEN 13X6,50-6 2PR	SHOE 13X6,50-6 2PR	PNEU 13X6,50-6 2PR	2								
22	A461761	BREMSZUGWIDERLAGER	BRACKET	EQUERRE-SUPPORT	1								
23	A46176401	PEDALAUFLAGE BREMSE UND KUPPL. R9005	CLAMP COVER FRONT	COUVRE ETRIER AVANT	1								
24	A46189340	STOSSSTANGE 30 MM LANG R9006 BRILL	BUMPER R9006	PARE-CHOCS	1								
25	A510566	SCHNELLBEFESTIGER 8SXN26	CROWN FASTENER	FIXATEUR A COURONNE	3								
26	A513010	SCHNELLBEFESTIGER16 SXN27	CROWN FASTENER	FIXATEUR A COURONNE	1								
27	A51404130	SPURSTANGE VERZ	STEERING ROD	BARRE DE DIRECTION	1								
28	A514042	BUCHSE-ACHSSCHENKEL	BRASS	COUSSINET	4								
29	A51406830	PEDAL RECHTS VERZ	DRIVE PEDAL	PEDALE TRANSMISSION	1								
30	A514224	HEBEL KPL.HÖHENVERSTELLUNG	LEVER	LEVIER	1								
31	A51424130	BEFESTIGUNGSBÜGEL SCHALTUNG VERZ	PLATE	PLAQUE	1								
32	A514299	PENDELANSCHLAG VERZ	BLOCK	BLOC	4								
33	A514307	DRUCKFEDER FÜR SITZ	SPRING	RESSORT	2								
34	A514316	SCHRAUBE SFS-TAPT 6X12 2019 A3R	SCREW	VIS	1								
35	A514327	DRUCKSCHALTER	PRESS SWITCH	INTERRUPTEUR À PRESSION	2								
36	A514346	ABDECKKAPPE D-35 RAL9005	HOOD	PROTECTEUR	2								
37	A51436030	LAGERBUCHSE-VORDERACHSE VERZ	SPACER	ENTRETOISE	1								
38	A514385	SCHALTERHALTER	SUPPORT	SUPPORT	1								

5/22		RASENTRAKTOREN		 RAHMENSATZ & LENKGETRIEBE CHASSIS & STEERING CHASSIS & BARRE DE DIRECTION	Crossover		2/3	
2007		LAWN TRACTORS			92 / 13 Hydro - Art. 65056			
Rev070601		Tracteurs de pelouse			Modell 2007			
Bild Nr. REF.N° POS.N°	BEST.-NR. PART-N° N° d. PIECE	BEZEICHNUNG	DESCRIPTION	DÉSIGNATION	Qty.			
39	A514386	DREHFEDER RECHTS	SPRING	RESSORT	1			
40	A51438730	DISTANZBUCHSE VERZ	SPACER	BAGUE D'ÉCARTEMENT	1			
41	A514396	BÜGEL	CONNECTING PLATE	PAQUE DE CONNEXION	1			
42	A514410	FESTSTELLFEDER RECHTS	SPRING	RESSORT	1			
43	A51442430	LAGERBOLZEN PEDAL VERZ.	PIN	PIVOT	1			
44	A51447701	PENDELACHSE GESCHW R9005	FLOATING AXLE	ABRE OSCILLANT	1			
45	A514701	WINKELGELENK CS16-M10+SIC	JOINT	JOINT	4			
46	A5148240110	RAHMEN 102CM R9005 NACHARBEIT	CHASSIS 102 R9005	CHASSIS 102 R9005	1			
47	A51484530	LAGERWELLE GESCHW VERZ	SHAFT	ARBRE	1			
48	A519076	ROHRSTOPFEN FÜR ROHR 30X2	COVER	BOUCHER	2			
49	A521123	SCHEIBE D50X5	WASHER	RONDELLE	1			
50	A521170	ACHSSCHENKEL LI.VZ.NEU ET	LEFT STUB AXLE	FUSEAU GAUCHE	1			
51	A521171	ACHSSCHENKEL RE.VZ.NEU ET	RIGHT STUB AXLE	FUSEAU DROITE	1			
52	A521268	ROLLENLAGER 20X30X55	ROLLER BEARING	COUSSINET	2			
53	A521361	STARTERRELAIS 12V/100AMPER	STARTER RELAY	RELAIS D'ALL.	1			
54	A521375	SKT-MUTTER+SPERRZ.1/4"-20 UN 8.8	NUT	ECROU	2			
55	A521395	VERSTELLKONSOLE SITZ GENIETET	PLATE	PLAQUE	1			
56	A521461	ANBINDUNGSBLECH RECHTS	STIFFENING RIGHT	RENFORCEMENT DROITE	1			
57	A521462	ANBINDUNGSBLECH LINKS	BRACKET LEFT	RENFORCEMENT GAUCHE	1			
58	A521475	WÄRMELEITBLECH UNTEN H-4 UND 2 ZYLINDER	LOWER HEAT GUARD	DÉFLECTEUR CHALEUR EN BAS	1			
59	A521480	FLÜGELSCHRAUBE M8X20	SCREW	VIS	2			
60	A521727	DISTANZBUCHSE	SPACER	ENTRETOISE	2			
61	A52185240	VORDERRAD 13X6.5-6 BREIT KPL R9006	FRONT WHEEL 13X6.5-6	ROUE AVANT 113X6.5-6	2			
62	A523134	SFS-TAPT.M6X12 2021 A2K	SCREW	VIS	1			
63	A546220	SCHLAUCH 13"X6.5"-6 TR13	TUBE	TUYAU	2			
64	A625877	SEGMENT "FE/ZN 12 F"	STEERING SHAFT	ARBRE DIRECTION	1			
65	A700051	SCHRAUBE 8X 20 912- 8.8 VZ	SCREW 8X 20 912- 8.8 VZ	VIS 8X 20 912- 8.8 VZ	2			
66	A700148	SCHEIBE 6,4 9021-ST VZ	WASHER	RONDELLE	5			
67	A700150	SCHEIBE 8,4 9021-ST VZ	WASHER	RONDELLE	4			
68	A700200	SCHEIBE FÄCHER- J 6,4 6798 VZ	WASHER	RONDELLE	2			
69	A700203	NIPPEL AS 6X1 KEG 71412	GREASE DISPENSER	GRAISSEUR	2			
70	A700545	SCHRAUBE 8X 16 933- 8.8VZ	SCREW 8X 16 933- 8.8VZ	VIS 8X 16 933- 8.8VZ	4			
71	A700555	SCHRAUBE 6X 16 933- 8.8VZ	SCREW	VIS	1			
72	A700719	SCHEIBE 21 433 VZ	WASHER	RONDELLE	1			
73	A701011	SCHRAUBE 8X 50 933- 8.8VZ	SCREW	VIS	4			
74	A701083	SCHEIBE 8,4VZ7349"701083"	WASHER	RONDELLE	1			
75	A701166	SCHEIBE PA 20X28X0,5 988	WASHER	RONDELLE	1			
76	A701395	BLINDNIET 4,0X 8	RIVET	RIVET	2			

6/22		RASENTRAKTOREN		 RAHMENSATZ & LENKGETRIEBE CHASSIS & STEERING CHASSIS & BARRE DE DIRECTION		Crossover		92 / 13 Hydro - Art. 65056 Modell 2007		3/3		 	
2007		LAWN TRACTORS				92 / 13 Hydro - Art. 65056							
Rev070601		Tracteurs de pelouse				Modell 2007							
Bild Nr. REF.N° POS.N°	BEST.-NR. PART-N° N° d. PIECE	BEZEICHNUNG	DESCRIPTION	DÉSIGNATION	Qty.								
77	A701478	MUTTER HUT 5 986- 8 VZ	NUT	ECROU	1								
78	A701765	SCHEIBE FÄCHER- A 8,4 6798 VZ	WASHER FÄCHER- A 8,4 6798 VZ	RONDELLE A 8,4 6798 VZ	4								
79	A701985	SCHRAUBE 8X 55 931- 8.8VZ	SCREW	VIS	1								
80	A702381	SCHRAUBE 8X 30 7991- 8.8 VZ	SCREW	VIS	1								
81	A702574	SCHEIBE PA 14X20X1,0 988 VZ	WASHER	RONDELLE	1								
82	A702724	SCHEIBE SICH 15 6799 VZ	WASHER	RONDELLE	3								
83	A702812	SHR10X 55 931- 8.8A3C	SCREW	VIS	1								
84	A702893	SCHEIBE SICH 10 6799 DAC	WASHER	RONDELLE	1								
85	A703005	SCHEIBE 6,4 9021-ST A3S	WASHER	RONDELLE	1								
86	A703813	MUTTER 6KT 10 985-10 A3B	NUT	ECROU	3								
87	A703974	SCHRAUBE 5X 20 965-4.8-H A3B	SCREW	VIS	1								
88	A704138	SCHRAUBE 6X 16 603- 4.6A3B	SCREW	ECROU	4								
89	A704368	SCHRAUBE 6X 18 933- 8.8A3C	SCREW	ECROU	2								
90	A704534	MUTTER 10 934- 8 A3B	NUT	ECROU	4								
91	A704536	MUTTER 6KT 6 985- 8 A3B	NUT	ECROU	8								
92	A704537	MUTTER 6KT 8 985- 8 A3B	NUT	ECROU	13								
93	A704540	SCHEIBE A 13 125-ST A3B	WASHER	RONDELLE	1								
94	A704546	SCHRAUBE 8X 20 933- 8.8A3B	SCREW	VIS	3								

Crossover  
 92 / 13 Hydro  
 Art. 65056

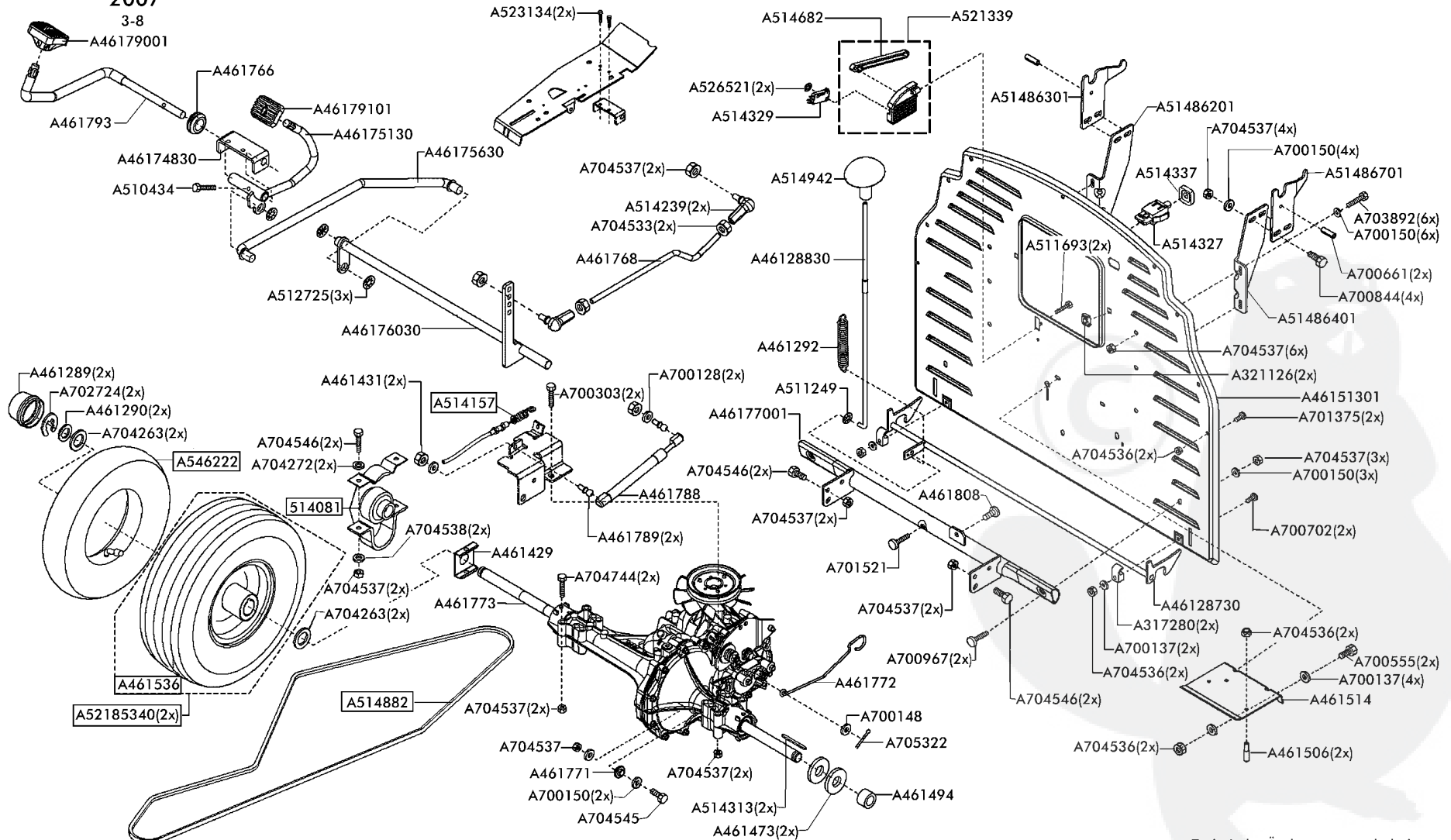

2007  
 3-8



Technische Änderungen vorbehalten

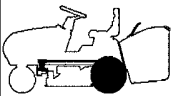

8/22	RASENTRAKTOREN	 GETRIEBE TRANSMISSION TRANSMISSION	Crossover			
2007	LAWN TRACTORS		92 / 13 Hydro - Art. 65056			1/2
Rev070601	Tracteurs de pelouse		Modell 2007			
Bild Nr. REF.N° POS.N°	BEST.-NR. PART.-N° N° d. PIECE	BEZEICHNUNG	DESCRIPTION	DÉSIGNATION	Qty.	
1	A317280	KABELSCHELLE	CABLE CLIP	COLLIER	2	
2	A321126	MUTTER KASTEN- M 6-ST GALVZ+PASSI	NUT M 6-ST GALVZ+PASSI	ECROU M 6-ST GALVZ+PASSI	2	
3	A46128730	BOXVERRIEGELUNG GESCHW VERZ	BOX LOCKING	BOX DISPOSITIF DE BLOCKAGE	1	
4	A46128830	VERRIEGELUNGSSTANGE VERZ	LOCKING ROD	BARRE DE BLOCKAGE	1	
5	A461289	ABDECKKAPPE"TRAKTOR"	HUB COVER	COUVRE MOYEU	2	
6	A461290	SCHEIBE 42MM FÜR TRAKTOR	WASHER	RONDELLE	2	
7	A461292	RÜCKHOLFEDER BOXVERRIEGELUNG	TENSION SPRING	RESSORT	1	
8	A461429	KLEMMBLECH 51118	CLAMP PLATE	BORNE	1	
9	A461431	MUTTER 5/16" UNC B	NUT	ECROU	2	
10	A461473	ANLAUFSCHLEIBE 52119	WASHER	RONDELLE	2	
11	A461494	DISTANZHÜSLE LINKES RAD HY-GEAR 310-051	SPACER	DOUILLE	1	
12	A461506	BOLZEN	BOLT	BOULLON	2	
13	A46151301	RÜCKWAND 102 R9005	REAR PANEL	PANNEAU ARRIERE	1	
14	A461514	RIEMENFÜHRUNG HINTEN	BELT GUIDE	GUIDE DE COURROIE	1	
15	A461536	MANTEL FÜR REIFEN 18X8,50-8 2PR	SHOE 18X8,50-8 2PR	PNEU 18X8,50-8 2PR	2	
16	A46174830	LAGERBOCK FÜR PEDAL VERZ	BEARING BRACKET	CHEVALET SUPPORT	1	
17	A46175130	PEDAL RÜCKWÄRTS GESCHW VERZ	PEDAL BACKWARD DRIVE	PEDAL EN ARRIÈRE	1	
18	A46175630	VERBINDUNGSSTAB GESCHW VERZ	CONNECTION ROD	BARRE DE CONNEXION	1	
19	A46176030	UMLENKUNG HINTEN GESCHW VERZ	SHAFT ASSY	LEVIER CPL	1	
20	A461766	DURCHFÜHRUNGSTÜLLE	FIXING RING	ANNEAU DE GUIDAGE	1	
21	A461768	GEWINDESTAB	THREAD ROD	TIGE FILETÉE	1	
22	A46177001	DREHMOMENTABSTÜTZUNG FUSSC GES R900	REAR SHAFT ASSY	ARBRE ARRIÈRE	1	
23	A461771	BUCHSE FÜR BREMSHEBEL VERZ	BUSH	DOILLE	1	
24	A461772	BYPASSHEBEL HYDRO FUSSCONTROL	LEVER HYDRO CONTROL	LEVIER CONTROLE HYDRO	1	
25	A461773	GETRIEBE-HYDRO GEAR FUSSC"358-0510"	HYDRO TRANSMISSION ASSY	TRANSMISSION AUTOMATIQUE HYDRO	1	
26	A461788	DÄMPFER 52406	BUFFER	AMORTISSEUR	1	
27	A461789	KUGELKOPF 51426	ADAPTER	ADAPTER	2	
28	A46179001	PEDALAUFLAGE VORWÄRTS HY-FUßS R9005	CLAMP COVER REAR	COUVRE ETRIER ARRIERE	1	
29	A46179101	PEDALAUFLAGE RÜCKWÄRTS HY-FUßS R9005	PEDAL BACKWARD	PEDAL EN ARRIÈRE	1	
30	A461793	PEDAL VORWÄRTS MIT SS HY-FUSSC R9005	PEDAL FORWARD	PEDAL EN AVANCER	1	
31	A461808	SCHRAUBE SKT 5/16" X 16 SELBSTSCHNEID	SCREW	VIS	1	
32	A510434	SCHRAUBE SFS-TAPT.6X20 2016	SCREW	VIS	1	
33	A511249	SCHNELLBEFESTIGER 7SXN26	CROWN FASTENER 7SXN26	FIXATEUR A COURONNE 7SXN26	1	
34	A511693	SCHRAUBE PT-KB 5X10 WN1411 A3B	SCREW	VIS	2	
35	A512725	SCHNELLBEFESTIGER14SXN26	CROWN FASTENER 14SXN26	FIXATEUR A COURONNE 14SXN26	3	
36	A514081	Y-STEHLAGER 3/4"	SUPPORT ASSY	SUPPORT CPL	1	
37	A514157	SCHALT-BOWDENZUG-BREMSE	BOWDEN CABLE	FIL	1	
38	A514239	WINKELGELENK C13SXN68/02R	JOINT	JOINT	2	



9/22		RASENTRAKTOREN		 GETRIEBE TRANSMISSION TRANSMISSION	Crossover		2/2	
2007		LAWN TRACTORS			92 / 13 Hydro - Art. 65056			
Rev070601		Tracteurs de pelouse			Modell 2007			
Bild Nr. REF.N° POS.N°	BEST.-NR. PART.-N° N° d. PIECE	BEZEICHNUNG	DESCRIPTION	DÉSIGNATION	Qty.			
39	A514313	PASSFEDER 3/16"X3/16"X2 1/4	FIT-IN KEY	GOUPILLE	2			
40	A514327	DRUCKSCHALTER	PRESS SWITCH	INTERRUPTEUR À PRESSION	1			
41	A514329	MIKROSCHALTER FÜLLSTANDANZEIGE	SWITCH	INTERRUPTEUR	1			
42	A514337	ABDECKTÜLLE FÜR DRUCKSCHALTER	COVER	COUVERCLE PROTECTION	1			
43	A514682	SCHALTHEBEL LANG	LEVER	LEVIER	1			
44	A51486201	LAGERARM RECHTS UNTEN R9005	LOWER BEARING ARM RIGHT	PALIER BRAS DROITE EN BAS	1			
45	A51486301	LAGERARM RECHTS OBEN R9005	UPPER BEARING ARM RIGHT	PALIER BRAS DROITE EN HAUT	1			
46	A51486401	LAGERARM LINKS UNTEN R9005	LOWER BEARING ARM LEFT	PALIER BRAS GAUCHE EN BAS	1			
47	A51486701	LAGERARM LINKS OBEN R9005	UPPER BEARING ARM LEFT	PALIER BRAS GAUCHE EN HAUT	1			
48	A514882	FAHRANTRIEBSRIEMEN 102 HD	DRIVE BELT 102 HD	COURROIE 102 HD	1			
49	A514942	VERRIEGELUNGSKNOPF R9005	ARRESTOR KNOB	BOUTON DE PRESSION ARRE.	1			
50	A521339	FÜLLSTANDSUMMERGEHÄUSE UND HEBEL	PROTECTION COVER & LEVER CPL	COUVERCLE PROTECTION & LEVIER CPL	1			
51	A52185340	HINTERRAD 18X8.5-8 BREIT KPL R9006	REAR WHEEL CPL 18X8.5-8	ROUE ARRIERE CPL 18X8.5-8	2			
52	A523134	SFS-TAPT.M6X12 2021 A2K	SCREW	VIS	2			
53	A526521	SCHNELLBEFESTIGER 3SXN26	CROWN FASTENER	FIXATEUR A COURONNE	2			
54	A546222	SCHLAUCH 18"X8.5"-8 / 9.50-8 TR13	HOSE 18"X8.5"-8 / 9.50-8 TR13	TUYAU 18"X8.5"-8 / 9.50-8 TR13	2			
55	A700128	RG FED- B 8 127 VZ	LOCK WASHER	DISQUE DE RESSORT	2			
56	A700137	SCHEIBE A 6,4 125-ST VZ	WASHER	RONDELLE	6			
57	A700148	SCHEIBE 6,4 9021-ST VZ	WASHER	RONDELLE	1			
58	A700150	SCHEIBE 8,4 9021-ST VZ	WASHER	RONDELLE	15			
59	A700303	SCHRAUBE 8X 70 931- 8.8VZ	SCREW	VIS	2			
60	A700555	SCHRAUBE 6X 16 933- 8.8VZ	SCREW	VIS	2			
61	A700661	HUEL SPAN 6 X 20 1481	BUSHING	DOUILLE	2			
62	A700702	SCHRAUBE 6X 25 933- 8.8VZ	SCREW	VIS	2			
63	A700844	SCHRAUBE 8X 20 603- 4.6VZ	SCREW	VIS	4			
64	A700967	SCHRAUBE 8X 35 603- 4.6VZ	SCREW	VIS	2			
65	A701375	SCHRAUBE 6X 12 7985- 4.8-H VZ	SCREW 8X 25 933- 8.8A3B	VIS 8X 25 933- 8.8A3B	2			
66	A701521	SCHRAUBE 8X 40 933- 8.8VZ	SCREW	VIS	1			
67	A702724	SCHEIBE SICH 15 6799 VZ	WASHER	RONDELLE	2			
68	A703892	SCHRAUBE 8X 45 933- 8.8A3B	SCREW	VIS	6			
69	A704263	SCHEIBE S 19X26X1,5 988A3C	WASHER	RONDELLE	4			
70	A704272	SCHEIBE PA 8X14X1,0 988	WASHER	RONDELLE	2			
71	A704533	MUTTER 8 934- 8 A3B	NUT	ECROU	2			
72	A704536	MUTTER 6KT 6 985- 8 A3B	NUT	ECROU	8			
73	A704537	MUTTER 6KT 8 985- 8 A3B	NUT	ECROU	26			
74	A704538	SCHEIBE A 8,4 125-ST A3B	WASHER	RONDELLE	2			
75	A704545	SCHRAUBE 8X 25 933- 8.8A3B	SCREW 8X 25 933- 8.8A3B	VIS 8X 25 933- 8.8A3B	1			
76	A704546	SCHRAUBE 8X 20 933- 8.8A3B	SCREW	VIS	6			
77	A704744	SCHRAUBE 8X 65 931- 8.8A3B	SCREW	VIS	2			
78	A705322	SPLINT 2 X 20 94 A3B	SPLINT	AUBIER	1			



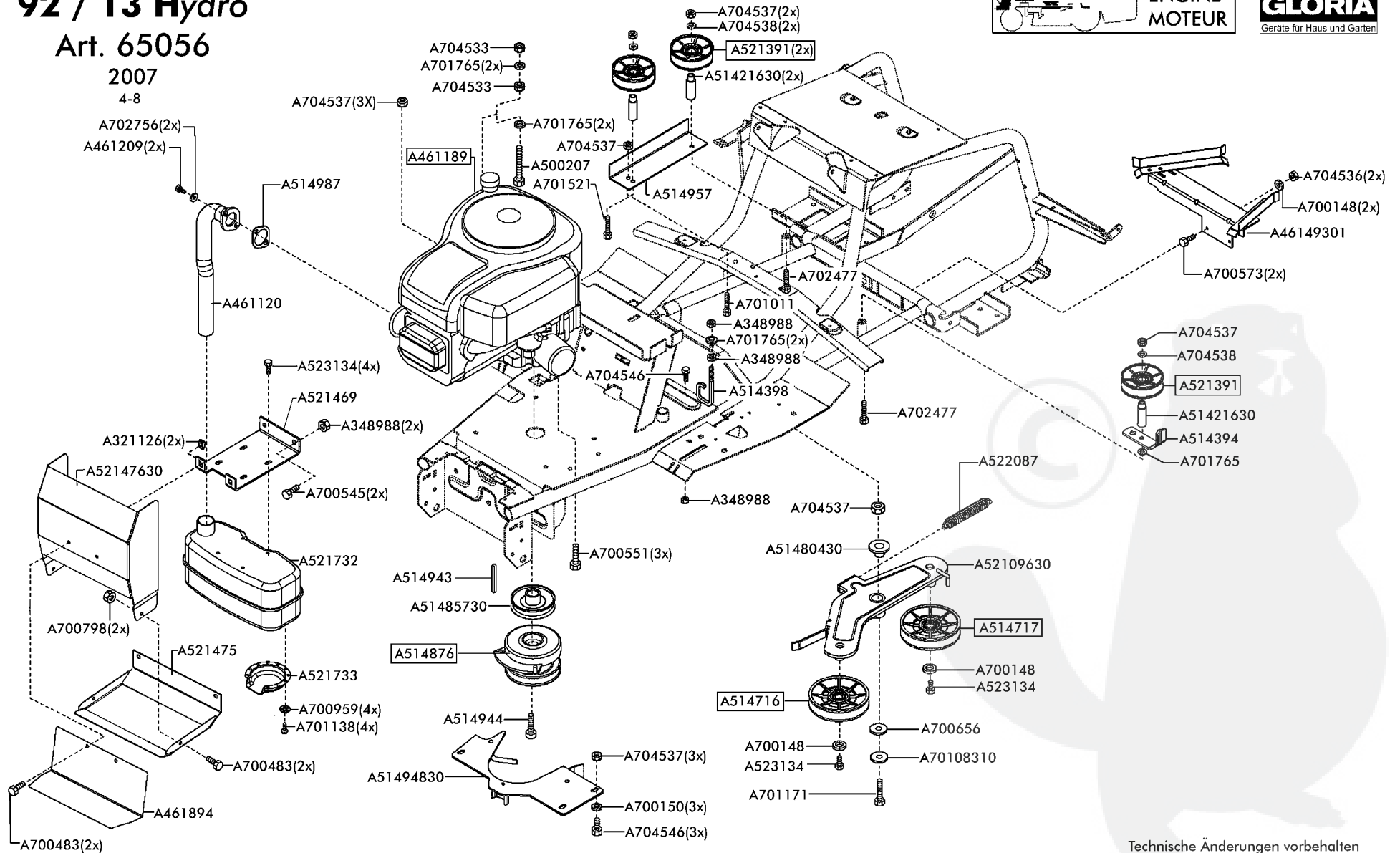
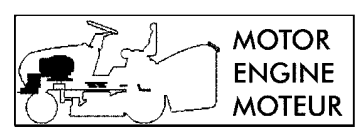

Crossover  
92 / 13 Hydro  
Art. 65056  
2007  
4-8

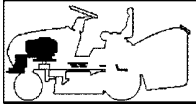

Technische Änderungen vorbehalten

11/22	RASENTRAKTOREN	 MOTOR ENGINE MOTEUR	Crossover		1/2	
2007	LAWN TRACTORS		92 / 13 Hydro - Art. 65056			
Rev070601	Tracteurs de pelouse		Modell 2007			
Bild Nr. REF.N° POS.N°	BEST.-NR. PART-N° N° d. PIECE	BEZEICHNUNG	DESCRIPTION	DÉSIGNATION	Qty.	
1	A321126	MUTTER KASTEN- M 6-ST GALVZ+PASSI	NUT M 6-ST GALVZ+PASSI	ECROU M 6-ST GALVZ+PASSI	2	
2	A348988	MUTTER SICHT- BIW M 8 A3C- 8 MITTELGESICHT	NUT	ECROU	5	
3	A461120	KRÜMMER B&S AUSPUFF GESCHW	EXHAUST CONNECTING TUBE	TUBE DE CONNEXION	1	
4	A461189	MOTOR B&S 13HP IC OHV AVS	ENGINE 13HP IC OHV AVS	MOTEUR 13HP IC OHV AVS	1	
5	A461209	SCHRAUBE ISKT UNC 5/16"X 3/4"A3B	SCREW	VIS	2	
6	A46149301	RIEMENFÜHRUNG HD102 GESCHW R9005	BELT GUIDE	GUIDAGE COURROIE	1	
7	A461894	ABWEISBLECH	PLATE	PLATEAU	1	
8	A500207	SCHRAUBE 8X 50 VERBUS RIPP A3R 8.8	SCREW	VIS	1	
9	A51421630	ZENTRIERHÜLSE VERZ.	BUSHING	DOILLE	3	
10	A514394	RIEMENFÜHRUNG VERZ	BELT GUIDE	GUIDAGE COURROIE	1	
11	A514398	ÖSE-RIEMENFÜHRUNG MITTE	BELT GUIDE	GUIDAGE	1	
12	A514716	SPANNROLLE INNEN +LAGER	TENSIONER INSIDE ASSY	ROUE SERRAGE	1	
13	A514717	SPANNROLLE AUSSEN+LAGER	TENSION ROLL ASSY. OUTSIDE	ROUE SERRAGE À L'EXTÉRIEUR	1	
14	A51480430	DISTANZBUCHSE WIPPE VERZ	SPACER	ENTRETOISE	1	
15	A51485730	ANTRIEBSSEGMENT BBC 102 GESCHW VERZ	PULLEY	POULLIE	1	
16	A514876	ELEKTR. KUPPLUNG BBC-102 I-5217-4 E	ELECTR. CLUTCH ASSY BBC-102 I-5217-4 E	EMBRAYAGE ÉLECTROMAGNETIQUE BBC-102 I	1	
17	A514943	PASSFEDER 1/4"X1/4"X1"A	FIT-IN KEY	GOUPILLE	1	
18	A514944	SCHRAUBE UNF 7/16"X3" 10.9	SCREW	VIS	1	
19	A51494830	RIEMENFÜHRUNG FAHRANTRIEB GESCHW VERZ	BELT GUIDE	GUIDE DE COURROIE	1	
20	A514957	FÜHRUNGSBLECH 5-GANG 102	PLATE	GUIDAGE	1	
21	A514987	FLANSCHDICHTUNG B&S 27229	FLANGE SEAL	JOINT	1	
22	A52109630	SPANNROLLENWIPPE D16 GESCHW VERZ	LEVER D16	LEVIER D16	1	
23	A521391	UMLENKROLLE ALU+LAGER	PULLEY ASSY	POULIE GUIDAGE CPL	3	
24	A521469	AUSPUFFHALTEBLECH	SUPPORT	SUPPORT	1	
25	A521475	WÄRMELEITBLECH UNTEN H-4 UND 2 ZYLINDER	LOWER HEAT GUARD	DÉFLECTEUR CHALEUR EN BAS	1	
26	A52147630	LUFTLEITBLECH 2-ZYLINDER VERZ	AIR GUIDE	DÉFLECTEUR	1	
27	A521732	AUSPUFF B&S P 498984	MUFFLER	SILENCEUX	1	
28	A521733	DEFLECTOR B&S P 222573	DEFLECTOR	DEFLECTEUR	1	
29	A522087	ZUGFEDER-BBC	SPRING	RESSORT	1	
30	A523134	SFS-TAPT.M6X12 2021 A2K	SCREW	VIS	6	
31	A700148	SCHEIBE 6,4 9021-ST VZ	WASHER	RONDELLE	4	
32	A700150	SCHEIBE 8,4 9021-ST VZ	WASHER	RONDELLE	3	
33	A700483	SCHRAUBE 6X 12 933- 8.8VZ	SCREW	VIS	4	
34	A700545	SCHRAUBE 8X 16 933- 8.8VZ	SCREW 8X 16 933- 8.8VZ	VIS 8X 16 933- 8.8VZ	2	
35	A700551	SCHRAUBE 8X 35 933- 8.8A3C	SCREW	VIS	3	
36	A700573	SCHRAUBE 6X 20 603- 4.6VZ	SCREW	VIS	2	
37	A700656	FED TEL 28 X10,2X1,25 2093	DISK SPRING	DISQUE	1	

12/22		RASENTRAKTOREN		 <b>MOTOR ENGINE</b> <b>MOTEUR</b>		Crossover		<b>92 / 13 Hydro - Art. 65056</b> Modell 2007		2/2  	
2007		LAWN TRACTORS									
Rev070601		Tracteurs de pelouse									
Bild Nr. REF.N° POS.N°	BEST.-NR. PART-N° N° d. PIECE	BEZEICHNUNG	DESCRIPTION	DÉSIGNATION	Qty.						
38	A700798	MUTTER 6KT 6 980-V- 8	NUT	ECROU	2						
39	A700959	SHB FÄCHER- A 4,3 6798 VZ	WASHER	RONDELLE	4						
40	A701011	SCHRAUBE 8X 50 933- 8.8VZ	SCREW	VIS	1						
41	A70108310	SCHEIBE 8,4VZ7349"701083"	WASHER	RONDELLE	1						
42	A701138	SCHRAUBE ST4,2X13 -C-H7981 VZ	SCREW	VIS	4						
43	A701171	SCHRAUBE 8X 30 933- 8.8VZ	SCREW	VIS	1						
44	A701521	SCHRAUBE 8X 40 933- 8.8VZ	SCREW	VIS	1						
45	A701765	SCHEIBE FÄCHER- A 8,4 6798 VZ	WASHER FÄCHER- A 8,4 6798 VZ	RONDELLE A 8,4 6798 VZ	7						
46	A702477	SCHRAUBE 8X 80 931- 8.8VZ	SCREW	VIS	2						
47	A702756	SCHEIBE SICH SCHNORR S 8 MECHANVZ	WASHER	RONDELLE	2						
48	A704533	MUTTER 8 934- 8 A3B	NUT	ECROU	2						
49	A704536	MUTTER 6KT 6 985- 8 A3B	NUT	ECROU	2						
50	A704537	MUTTER 6KT 8 985- 8 A3B	NUT	ECROU	11						
51	A704538	SCHEIBE A 8,4 125-ST A3B	WASHER	RONDELLE	3						
52	A704546	SCHRAUBE 8X 20 933- 8.8A3B	SCREW	VIS	4						



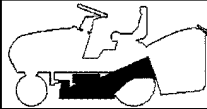



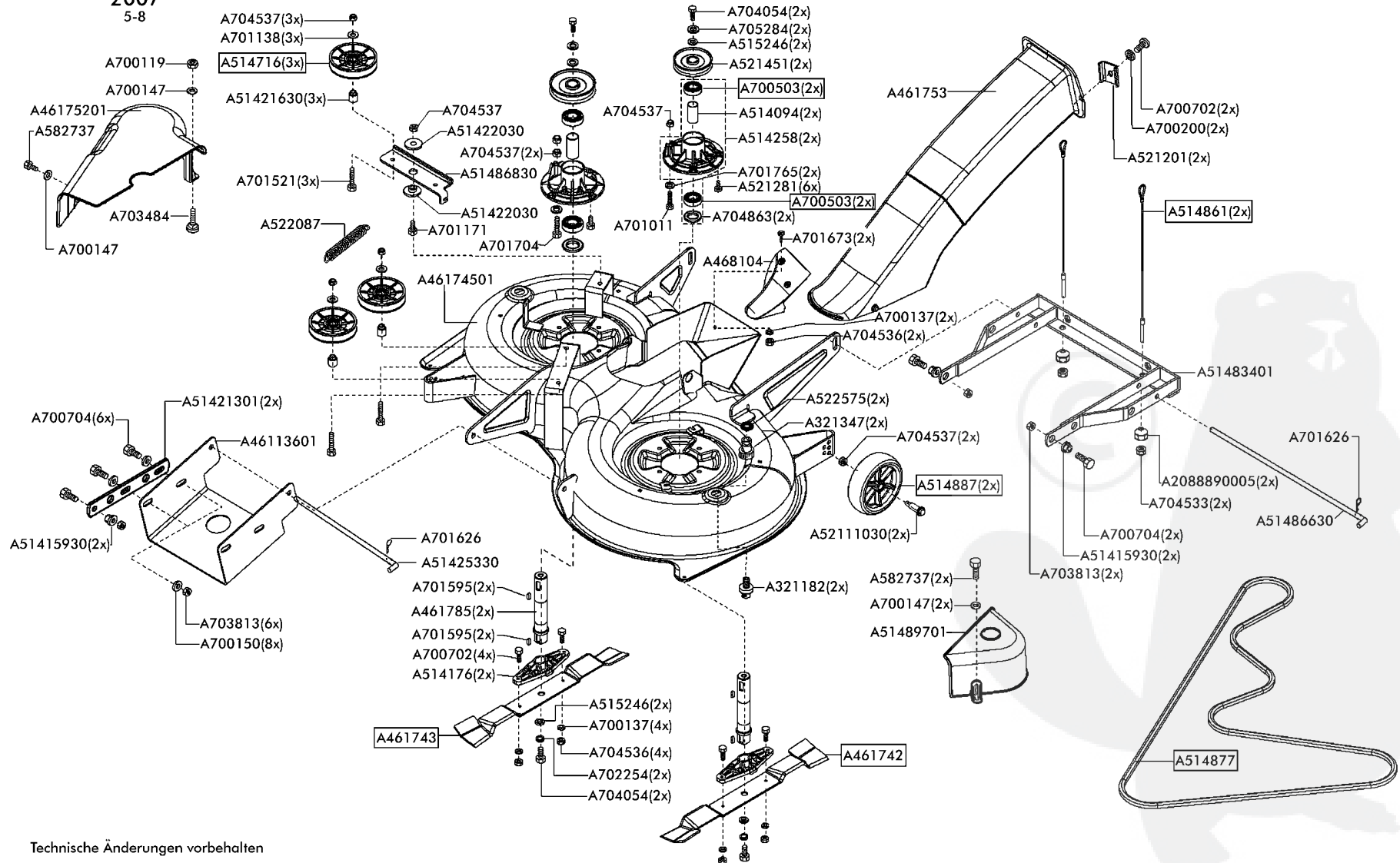
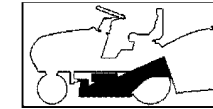

Crossover  
 92 / 13 Hydro  
 Art. 65056  
 2007  
 5-8



Technische Änderungen vorbehalten

14/22	RASENTRAKTOREN		SCHNEIDWERK CUTTING PLATE PLATEAU DE COUPE	Crossover	92 / 13 Hydro - Art. 65056	1/2	
2007	LAWN TRACTORS						
Rev070601	Tracteurs de pelouse						
Bild Nr. REF.N° POS.N°	BEST.-NR. PART-N° N° d. PIECE	BEZEICHNUNG	DESCRIPTION	DÉSIGNATION	Qty.		
1	A2088890005	KUGELMUTTER M8	NUT	ECROU	2		
2	A321182	SPÜLDÜSE R1/2"	WATER HOSE CONNECTION	RACCORD TUYAU D'EAU	2		
3	A321347	ANSCHLUSS R1/2"	TUBE ADAPTER	ADAPTER TUYAU	2		
4	A46113601	MÄHDECKAUFHÄNGUNG VORNE R9005	CUTTING PLATE SUPPORT FRONT	PLATEAU SUSPENSION L'AVANT	1		
5	A461742	MESSER 487MM LINKS	BLADE LEFT 487 MM	LAME GAUCHE 487 MM	1		
6	A461743	MESSER 487MM RECHTS	BLADE RIGHT 487 MM	BLADE LEFT 487 MM	1		
7	A46174501	SCHNEIDGEHÄUSE 92 CM GESCHW R9005	CUTTING DECK 92 CM R9005	CARTER 92 CM R9005	1		
8	A46175201	ABDECKUNG MÄHANTRIEB RECHTS R9005 95	COVER RIGHT; CUTTING DRIVE	COUVERCLE DE PROTECTION COM.TONDRE	1		
9	A461753	AUSWURFKANAL 92CM	FUNNEL 92 CM	CANAL CRACHAT	1		
10	A461785	MESSERWELLE TRAKTOR VERZ	BLADE SHAFT	ABRE	2		
11	A468104	6160-701-1600-A EINSATZ"KANALZUNGE"	FUNNEL INSERT 6160-701-1600-A	CANAL INSERT	1		
12	A514094	DISTANZBUCHSE-1	SPACER	ENTRETOISE	2		
13	A51415930	DISTANZSCHEIBE VERZ	SPACER	ENTRETOISE	4		
14	A514176	MESSERHALTER	BLADE FLANGE	BRIDE	2		
15	A51421301	SCHENKEL-VORNE HÖHENVERSTELLUNG R9005	SUPPORT	SUPPORT	2		
16	A51421630	ZENTRIERHÜLSE VERZ.	BUSHING	DOILLE	3		
17	A51422030	DISTANZSCHEIBE VERZ	SPACER	ENTRETOISE	2		
18	A51425330	ABSTECKSTANGE VERZ.	ROD	BARRE	1		
19	A514258	LAGERBOCK KPL.	BLADE FLANGE ASSY. CPL	ENS. BRIDE POUR LAME CPL	2		
20	A514716	SPANNROLLE INNEN +LAGER	TENSIONER INSIDE ASSY	ROUE SERRAGE	3		
21	A51483401	AUFHÄNGUNG HINTEN 102 GESCHW R9005	REAR FRAME	SUSPENSION ARRIÈRE 102	1		
22	A514861	DRAHTSEIL	STEEL WIRE ROPE	CABLE D'ACIER	2		
23	A51486630	ABSTECKSTANGE HINTEN VERZ	ROD	BARRE	1		
24	A51486830	SPANNWIPPE BBC VZKT	SUPPORT	SUPPORT	1		
25	A514877	MÄHANTRIEBSRIEMEN 102	V-BELT 102	COURROIE 102	1		
26	A514887	RAD 125 R9005	WHEEL 125 CPL	ROUE CPL 125	2		
27	A51489701	ABDECKUNG MÄHANTRIEB LINKS R9005	BELT COVER LEFT	BARRIÈRE GAUCHE CPL	1		
28	A515246	SCHEIBE 30/10,5 X 5	WASHER	RONDELLE	4		
29	A52111030	RADBOLZEN 102 VERZ	WHEEL BOLT	BOULLON ROUE	2		
30	A521201	FIXIERUNGSSCHEIBE 102	FIXING PLATE	PLATEAU FIXATION	2		
31	A521281	SCHRAUBE-TAPT 8X25 SPERRZ.A3S	SCREW	VIS	6		
32	A521451	RIEMENSCHLEIBE VERSCHRAUBT 102 KPL	PULLEY ASSY	POULIE	2		
33	A522087	ZUGFEDER-BBC	SPRING-BBC	RESSORT-BBC	1		
34	A522575	O-RING D10,78X2,62 NBR	O-RING	O-RING	2		
35	A582737	SCHRAUBE DUO-TAP 5X10-C ST A2K	SCREW DUO-TAP 5X10-C ST A2K	VIS DUO-TAP 5X10-C ST A2K	3		
36	A700119	MUTTER 6KT 5 985- 8 VZ	NUT	ECROU	1		
37	A700137	SCHEIBE A 6,4 125-ST VZ	WASHER	RONDELLE	6		

15/22	RASENTRAKTOREN		SCHNEIDWERK CUTTING PLATE PLATEAU DE COUPE	Crossover <b>92 / 13 Hydro - Art. 65056</b> Modell 2007	2/2	
2007	LAWN TRACTORS					
Rev070601	Tracteurs de pelouse					
Bild Nr. REF.N° POS.N°	BEST.-NR. PART-N° N° d. PIECE	BEZEICHNUNG	DESCRIPTION	DÉSIGNATION	Qty.	
38	A700147	SCHEIBE 5,3 9021-ST VZ	WASHER	RONDELLE	4	
39	A700150	SCHEIBE 8,4 9021-ST VZ	WASHER	RONDELLE	8	
40	A700200	SCHEIBE FÄCHER- J 6,4 6798 VZ	WASHER	RONDELLE	2	
41	A700503	KUGELLAGER 6205 2RS 625	BALL BEARING	ROULEMENT À BILLES	4	
42	A700702	SCHRAUBE 6X 25 933- 8.8VZ	SCREW	VIS	6	
43	A700704	SCHRAUBE10X 30 933- 8.8VZ	SCREW	VIS	8	
44	A701011	SCHRAUBE 8X 50 933- 8.8VZ	SCREW	VIS	1	
45	A701138	SCHRAUBE ST4,2X13 -C-H7981 VZ	SCREW	VIS	3	
46	A701171	SCHRAUBE 8X 30 933- 8.8VZ	SCREW	VIS	1	
47	A701521	SCHRAUBE 8X 40 933- 8.8VZ	SCREW	VIS	3	
48	A701595	PASSFEDER 8X7X20 6885	FIT-IN KEY	GOUPILLE	3	
49	A701626	FEDERSTECKER - 2,5 11024 VZ	COTTER PIN	GOUPILLE	2	
50	A701673	SCHRAUBE 6X 25 603- 4.6VZ	SCREW 6X 25 603- 4.6VZ	VIS 6X 25 603- 4.6VZ	2	
51	A701704	SCHRAUBE 8X 60 933- 8.8VZ	SCREW	VIS	1	
52	A701765	SCHEIBE FÄCHER- A 8,4 6798 VZ	WASHER FÄCHER- A 8,4 6798 VZ	RONDELLE A 8,4 6798 VZ	2	
53	A702254	SCHEIBE FÄCHER- A 10,5 6798 VZ	WASHER	RONDELLE	2	
54	A703484	SCHRAUBE 5X 16 603- 4.6A3C	SCREW	VIS	1	
55	A703813	MUTTER 6KT 10 985-10 A3B	NUT	ECROU	8	
56	A704054	SCHRAUBE10X1,0 X 35 961- 8.8	SCREW	VIS	4	
57	A704533	MUTTER 8 934- 8 A3B	NUT	ECROU	2	
58	A704536	MUTTER 6KT 6 985- 8 A3B	NUT	ECROU	6	
59	A704537	MUTTER 6KT 8 985- 8 A3B	NUT	ECROU	9	
60	A704863	RWDR AS 30X 52X 5 3760-NB	WASHER	RONDELLE	2	
61	A705284	TELLERFEDER 28 X10,2X1,5 2093	DISK SPRING	RESSORT D'ASSIETTE	2	



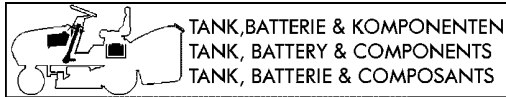

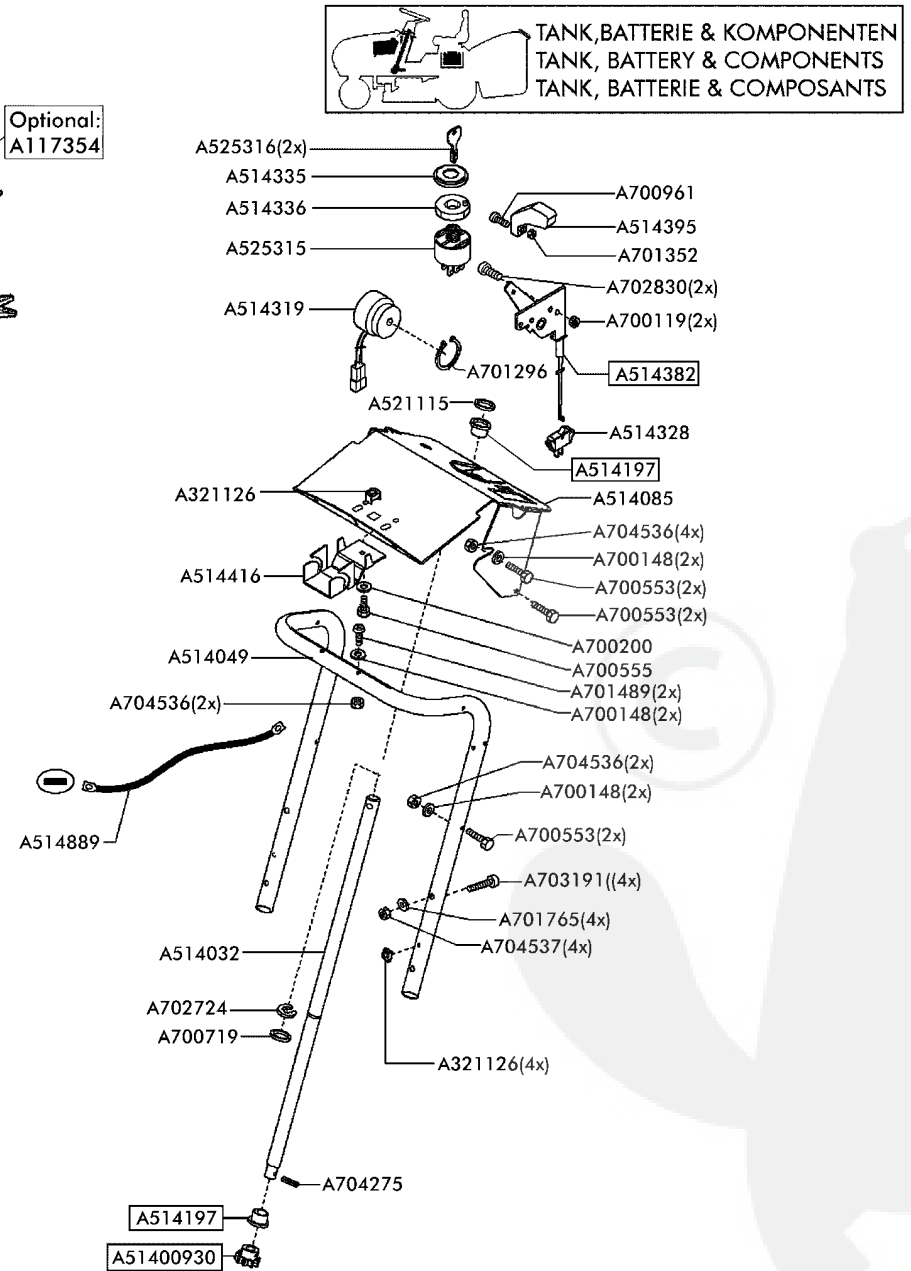
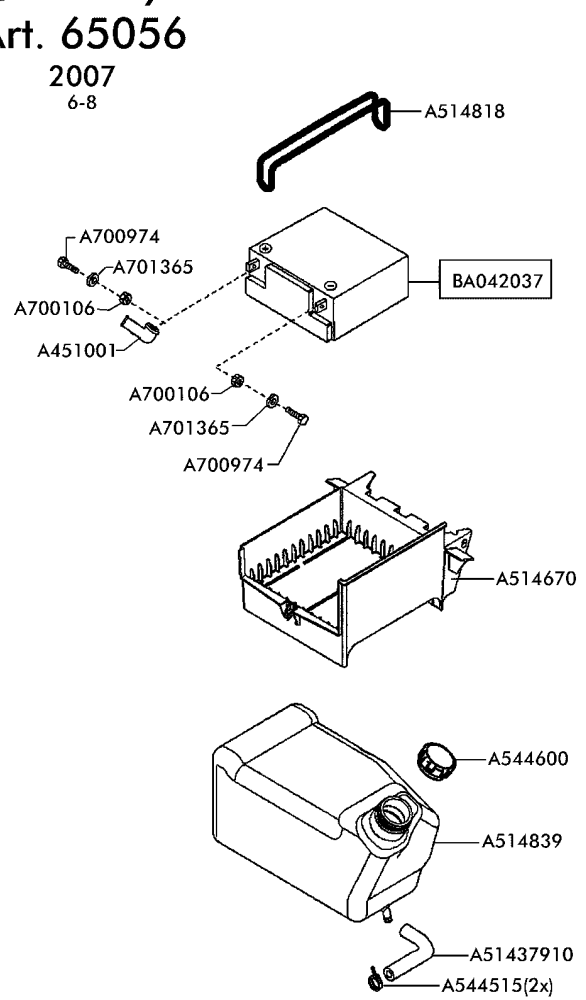

**Crossover**  
**92 / 13 Hydro**  
 Art. 65056  
 2007  
 6-8



Technische Änderungen vorbehalten

17/22		RASENTRAKTOREN		Crossover	
2007		LAWN TRACTORS		92 / 13 Hydro - Art. 65056	
Rev070601		Tracteurs de pelouse		Modell 2007	
				1/2	
Bild Nr. REF.N° POS.N°	BEST.-NR. PART-N° N° d. PIECE	BEZEICHNUNG	DESCRIPTION	DÉSIGNATION	Qty.
1	A117354	LADEGERÄT Crossover 12 V (optional)	CHARGER Crossover 12 V (optional)	CHARGEUR Crossover 12 V (optional)	1
2	A321126	MUTTER KASTEN- M 6-ST GALVZ+PASSI	NUT	ECROU	4
3	A451001	BATTERIEPOLABDECKUNG FÜR BATTERIE CSB	POL COVER	COUVERCLE DE PROTECTION	1
4	A51400930	LENKUNGSRITZEL VERZ.	STEERING WHEEL	PIGNON	1
5	A514032	LENKSÄULE VERZ	STEERING COLUMN	TUBE DE DIRECTION	1
6	A514049	STÜTZHOLM	SUPPORT	SUPPORT	1
7	A514085	STÜTZBLECH	SUPPORT	SUPPORT	1
8	A514197	EP-BUNDBUCHSE	BUSH	DOILLE	2
9	A514319	FÜLLSTANDSUMMER	BUZZER (GRASS BAG FULL)	BUZZER	1
10	A514328	KIPPSCHALTER LICHT	ROCKER SWITCH I/O	INERRUPTEUR À BASCULE	1
11	A514335	BEFESTIGUNGS MUTTER ZÜNDSCHLOSS	LOCK NUT	EMBOUT	1
12	A514336	VERDREHSICHERUNG ZÜNDSCHLOSS	SAFETY NUT	EMBOUT	1
13	A51437910	BENZINSCHLAUCH ZUSCHNITT	CONNECTING TUBE	TUBE DE CONNEXION	1
14	A514382	GASFERNBEDIENUNG	ACCELERATOR	ACCELERATEUR	1
15	A514395	BEDIENHEBEL	LEVER	LEVIER	1
16	A514416	EINRASTBLECH	ENGAGE PLATE	PANNEAU ENCLIQUETER	1
17	A514670	BATTERIEKASTEN	BATTERY INSERT	BATTERIE CAISSE	1
18	A514818	BEFESTIGUNGSGUMMI	RUBBER BAND	ÉLASTIQUE	1
19	A514839	BENZINTANK	TANK	RESERVOIR	1
20	A514889	ZUSATZ MASSEKABEL	GROUND CABLE	CABLE	1
21	A521115	SCHNELLBEFESTIGER20SXN26	CROWN FASTENER	FIXATEUR A COURONNE	1
22	A525315	ZÜNDANLASSCHALTER RIDER	IGNITION SWITCH	INTERRUPTEUR DEMARR. /1	1
23	A525316	ZÜNDSCHLÜSSEL	STARTING KEY	CLEF A DEMARRAGE	2
24	A544515	SCHLAUCHKLEMME 14,5	TUBE CLAMP	BORNE	2
25	A544600	TANKDECKEL KPL	TANK CAP	BOUCHON DE RÉSERVOIR	1
26	A700106	MUTTER 5 934- 8 VZ	NUT	ECROU	2
27	A700119	MUTTER 6KT 5 985- 8 VZ	NUT	ECROU	2
28	A700148	SCHEIBE 6,4 9021-ST VZ	WASHER	RONDELLE	6
29	A700200	SCHEIBE FÄCHER- J 6,4 6798 VZ	WASHER	RONDELLE	1
30	A700553	SCHRAUBE 6X 40 933- 8.8VZ	SCREW	VIS	6
31	A700555	SCHRAUBE 6X 16 933- 8.8VZ	SCREW	VIS	1
32	A700719	SCHEIBE 21 433 VZ	WASHER	RONDELLE	1
33	A700961	SCHRAUBE 4X 8 7985- 4.8-H VZ	SCREW	VIS	1
34	A700974	SCHRAUBE 5X 16 933- 8.8VZ	SCREW	VIS	2
35	A701296	SICHERUNGSRING 25X1,2 471	CIRCLIP	CIRCLIPS	1
36	A701352	MUTTER 6KT 4 985- 8 VZ	NUT	ECROU	1
37	A701365	SCHEIBE FÄCHER- A 5,3 6798 VZ	WASHER	RONDELLE	2

<b>18/22</b>	<b>RASENTRAKTOREN</b>		TANK, BATTERIE & KOMPONENTEN	<b>Crossover</b>		
2007	<b>LAWN TRACTORS</b>		TANK, BATTERY & COMPONENTS	<b>92 / 13 Hydro - Art. 65056</b>		2/2
Rev070601	<b>Tracteurs de pelouse</b>		TANK, BATTERIE & COMPOSANTS	<b>Modell 2007</b>		
<b>Bild Nr.</b> <b>REF.N°</b> <b>POS.N°</b>	<b>BEST.-NR.</b> <b>PART-N°.</b> <b>N° d. PIECE</b>	<b>BEZEICHNUNG</b>	<b>DESCRIPTION</b>	<b>DÉSIGNATION</b>	<b>Qty.</b>	
38	A701489	SCHRAUBE 6X 35 933- 8.8VZ	SCREW	VIS	2	
39	A701765	SCHEIBE FÄCHER- A 8,4 6798 VZ	WASHER FÄCHER- A 8,4 6798 VZ	RONDELLE FÄCHER- A 8,4 6798 VZ	4	
40	A702724	SCHEIBE SICH 15 6799 VZ	WASHER	RONDELLE	1	
41	A702830	SCHRAUBE 5X 12 7985- 4.8-H A3R	SCREW	VIS	2	
42	A703191	SCHRAUBE 8X 40 7991- 8.8A3C	SCREW	VIS	4	
43	A704275	SPANNSTIFT 6X24 7344	PIN	GOUPILLE	1	
44	A704536	MUTTER 6KT 6 985- 8 A3B	NUT	ECROU	8	
45	A704537	MUTTER 6KT 8 985- 8 A3B	NUT	ECROU	4	
46	BA042037	BATTERIE 12V-17Ah	BATTERY 12 V-17Ah	BATTERIE 12V-17Ah	1	



Crossover  
92 / 13 Hydro  
Art. 65056  
2007  
7-8

GRASFANGSACK KPL.  
GRASS CATCHER ASSY.  
BAC COMPOSANTS

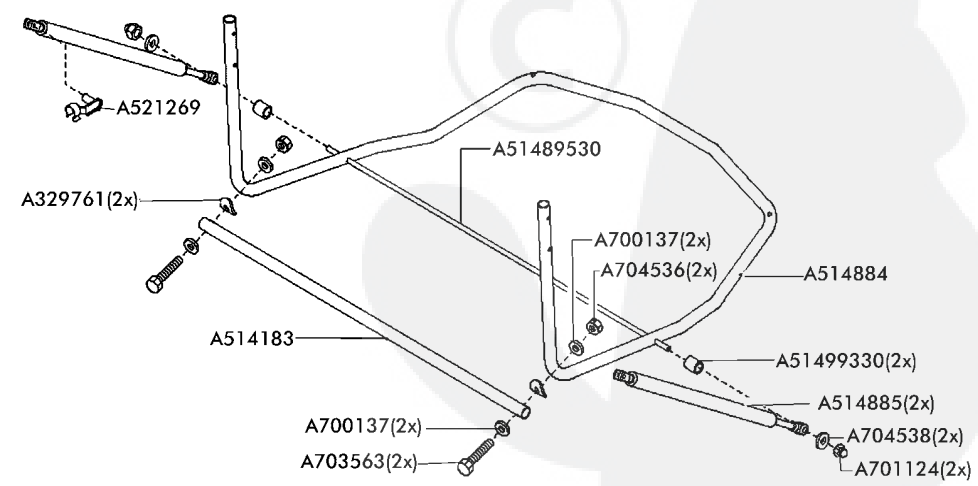
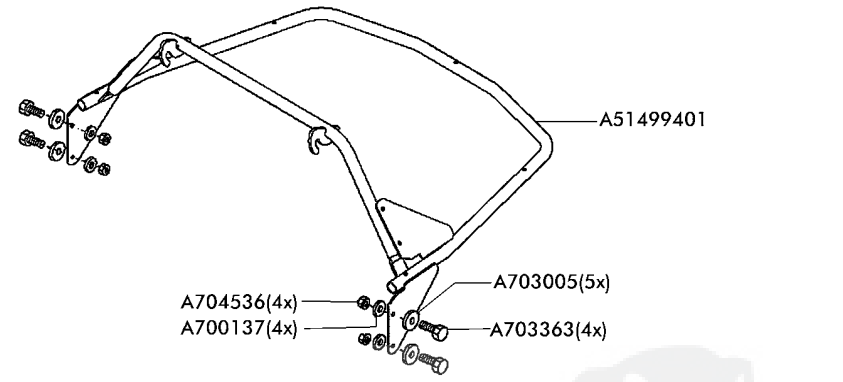
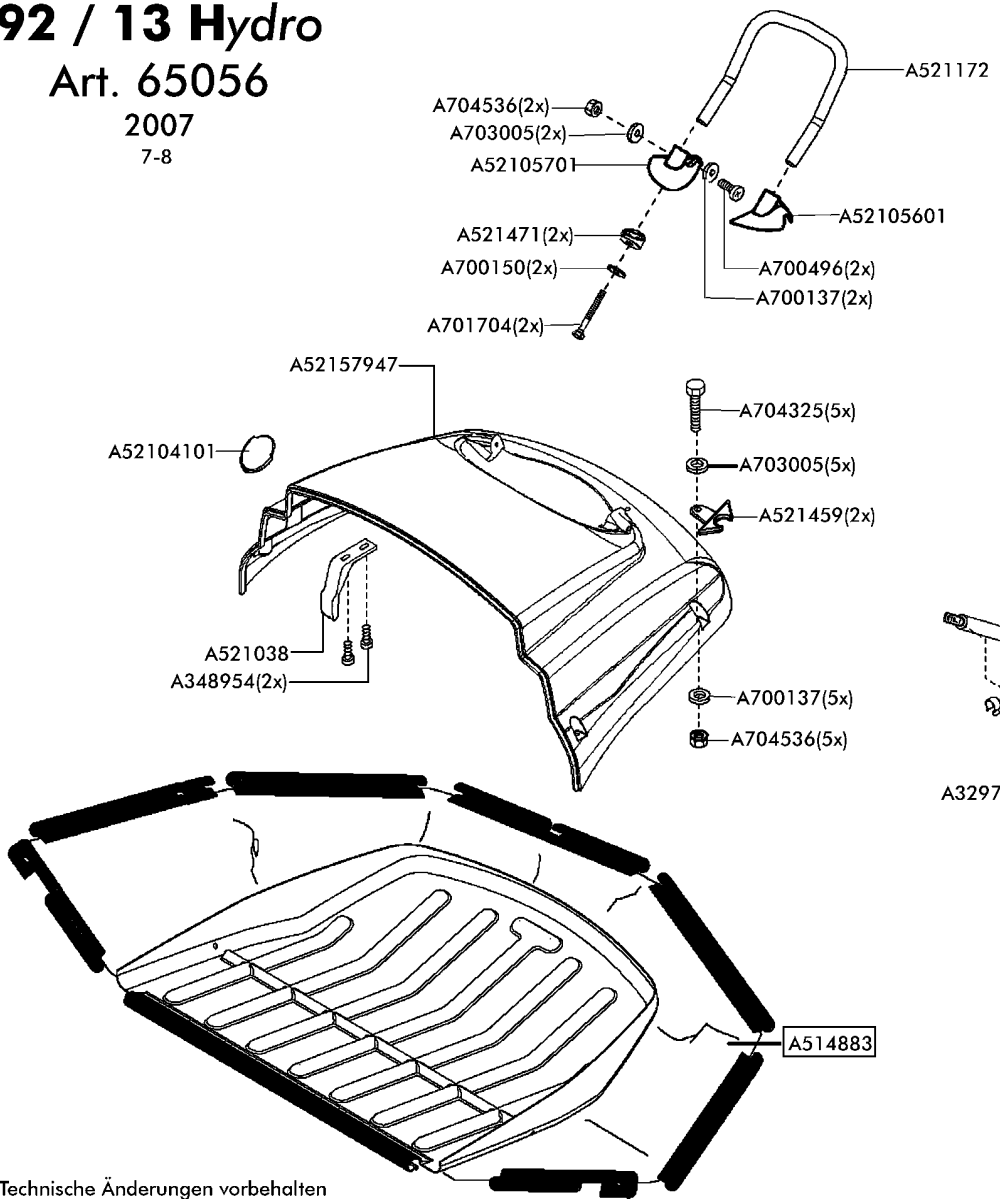

Technische Änderungen vorbehalten

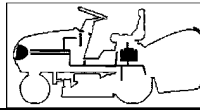

20/22		RASENTRAKTOREN			GRASFANGSACK KPL. GRASS CATCHER ASSY. BAC COMPOSANTS		Crossover		92 / 13 Hydro - Art. 65056			
2007		LAWN TRACTORS					Modell 2007					
Rev070601		Tracteurs de pelouse										
Bild Nr. REF.N° POS.N°	BEST.-NR. PART-N° N° d. PIECE	BEZEICHNUNG			DESCRIPTION			DÉSIGNATION			Qty.	
1	A329761	SCHEIBE GEBOGEN H11			CURVED WASHER H11			RONDELLE COURBE			2	
2	A348954	SCHRAUBE.PT-KB 60X25 1411 VZ			SCREW			VIS			2	
3	A514183	QUERSTREBE BOX			ROD			TIGE			1	
4	A514883	GEWEBESACK 102 KPL			GRASS CATCHER BAG ASSY 102			BAC			1	
5	A514884	BOXROHR UNTEN 102			LOWER FRAME ASSY			CHASSIS INFÉRIEUR			1	
6	A514885	GASFEDER GF8-053550-130			GAS PRESSURE SPRING GF8-053550-130			RESSORT PNEUMATIQUE GF8-053550-130			2	
7	A51489530	BOXSTREBE TRAKTOR 102 VERZ			BOX BAR			BAC HAUBAN			1	
8	A51499330	DISTANZHÜLSE BOX VERZ			DISTANCE SLEEVE			CALE DE DISTANCE			2	
9	A51499401	BOXROHR 102 GESCHW R9005			BOX TUBE			BAC TUYAU			1	
10	A521038	KONTAKTWINKEL			BRACKET			EQUERRE-SUPPORT			1	
11	A52104101	VERSCHLUSSTOPFEN R9005			CAP			BOUCHON			1	
12	A52105601	AUFSATZ LINKS R9005			ADAPTER LEFT			ADAPTER GAUCHE			1	
13	A52105701	AUFSATZ RECHTS R9005			ADAPTER RIGHT			ADAPTER DROITE			1	
14	A521172	BOXGRIFF + ROHREINS.M8 KP			HANDLE			POINGEE			1	
15	A521269	FEDERKLAPPBOLZEN FKB 6X12			SPRING SNAP BOLT			BOULON BLOQUER			1	
16	A521459	CLIP FÜR GASDÄMPFERBEFESTIGUNG			CLIP			CLIP			2	
17	A521471	UNTERLAGSCHEIBE FÜR GRIFF			WASHER			RONDELLE			2	
18	A52157947	BOXDECKEL TR 2X BOHREN			BAG COVER			COUVRE-BAC VERT			1	
19	A700137	SCHEIBE A 6,4 125-ST VZ			WASHER			RONDELLE			15	
20	A700150	SCHEIBE 8,4 9021-ST VZ			WASHER			RONDELLE			2	
21	A700496	SCHRAUBE 6X 20 912- 8.8			SCREW			VIS			2	
22	A701124	MUTTER HUT 8 986- 8 VZ			NUT			ECROU			2	
23	A701704	SCHRAUBE 8X 60 933- 8.8VZ			SCREW			VIS			2	
24	A703005	SCHEIBE 6,4 9021-ST A3S			WASHER			RONDELLE			12	
25	A703363	SCHRAUBE 6X 35 933- 8.8A3S			SCREW			VIS			4	
26	A703563	SCHRAUBE 6X 45 933- 8.8A3C			SCREW			VIS			2	
27	A704325	SCHRAUBE 6X 40 933- 8.8A3S			SCREW			VIS			5	
28	A704536	MUTTER 6KT 6 985- 8 A3B			NUT			ECROU			13	
29	A704538	SCHEIBE A 8,4 125-ST A3B			WASHER			RONDELLE			2	

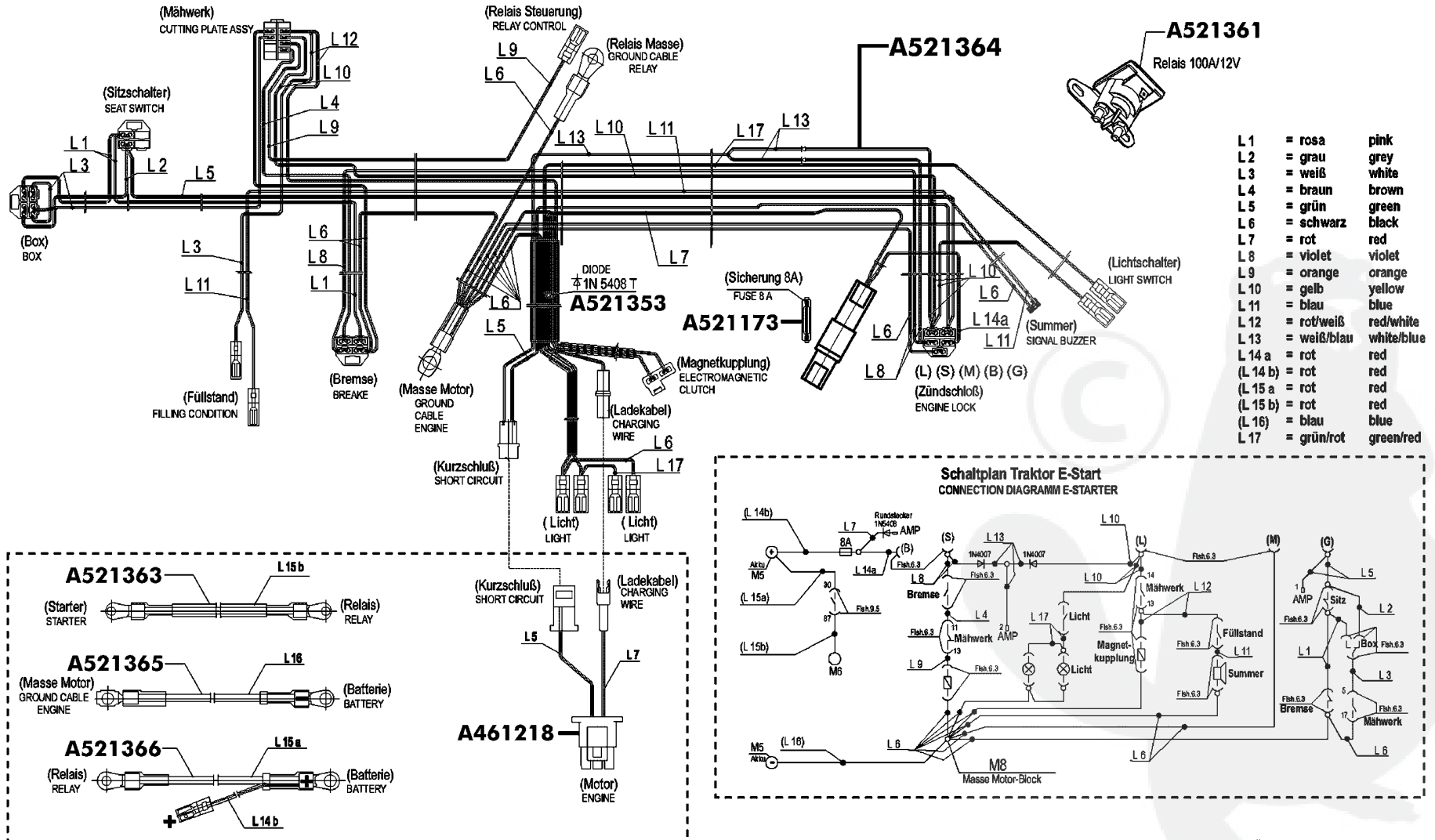
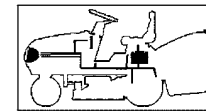

Crossover  
**92 / 13 Hydro**  
 Art. 65056  
 2007  
 8-8

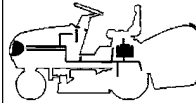

Technische Änderungen vorbehalten

<b>22/22</b>	RASENTRAKTOREN		ELEKTRIK 1 ELECTRIC 1 ELECTRIQUES 1	<b>Crossover</b>		 
2007	LAWN TRACTORS			<b>92 / 13 Hydro - Art. 65056</b>		
Rev070601	Tracteurs de pelouse			Modell 2007		
Bild Nr. REF.N° POS.N°	BEST.-NR. PART-N° N° d. PIECE	BEZEICHNUNG	DESCRIPTION	DÉSIGNATION	Qty.	
1	A461218	ADAPTER FÜR KABELB TEC 14 HP+13 HP B&S	ADAPTER FOR TEC 14 HP+13 HP B&S	ADAPTER POUR TEC 14 HP+13 HP B&S	1	
2	A521173	SICHERUNG 8A	FUSE 8A	FUSIBLE 8A	1	
3	A521353	DIODE 5A IN5408 T ET	DIODE 5A	DIODE 5A	1	
4	A521361	STARTERRELAIS 12V/100AMPER	STARTER RELAY	RELAIS D'ALL.	1	
5	A521363	KABEL ROT STARTER/RELAIS	CABLE RED (RELAIS)	CABLE ROUGE (RELAIS)	1	
6	A521364	KABELBAUM E-START 102	CABLES ASSY. E-START 102	ENS. CABLAGES E-START 102	1	
7	A521365	KABEL BLAU MASSELEITER	CABLE BLUE (GROUNG CABLE)	CABLE BLEU	1	
8	A521366	KABEL ROT BATTERIE/RELAIS	CABLE RED BATTERY * RELAIS	CABLE ROUGE (BATTERIE-RALAIS)	1	

