

RASENTRAKTOREN
LAWN TRACTORS
Tracteurs de pelouse

Inhaltsverzeichnis
Table of contents
Tables de matières





Modelle 2007

Crossover

102 / 15

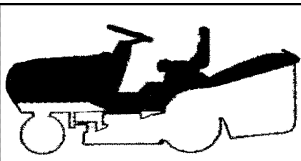
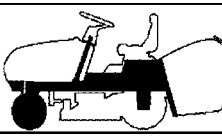
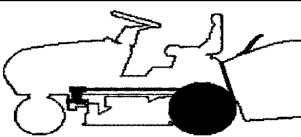
Art. 65058

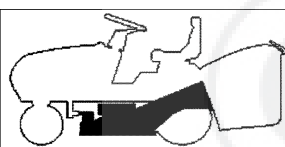
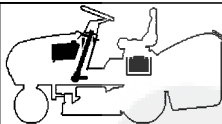
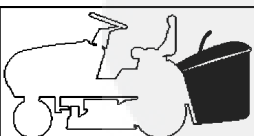
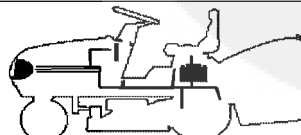
1	 <p>KARROSSERIE BODY CARROSSERIE</p>
2	 <p>RAHMENSATZ & LENKGETRIEBE CHASSIS & STEERING CHASSIS & BARRE DE DIRECTION</p>
3	 <p>GETRIEBE TRANSMISSION TRANSMISSION</p>
4	 <p>MOTOR ENGINE MOTEUR</p>
5	 <p>SCHNEIDWERK CUTTING PLATE PLATEAU DE COUPE</p>
6	 <p>TANK, BATTERIE & KOMPONENTEN TANK, BATTERY & COMPONENTS TANK, BATTERIE & COMPOSANTS</p>
7	 <p>GRASFANGSACK KPL. GRASS CATCHER ASSY. BAC COMPOSANTS</p>
8	 <p>ELEKTRIK 1 ELECTRIC 1 ELECTRIQUES 1</p>

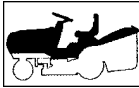

Crossover
102/15
Art. 65058
 2007
 1-8

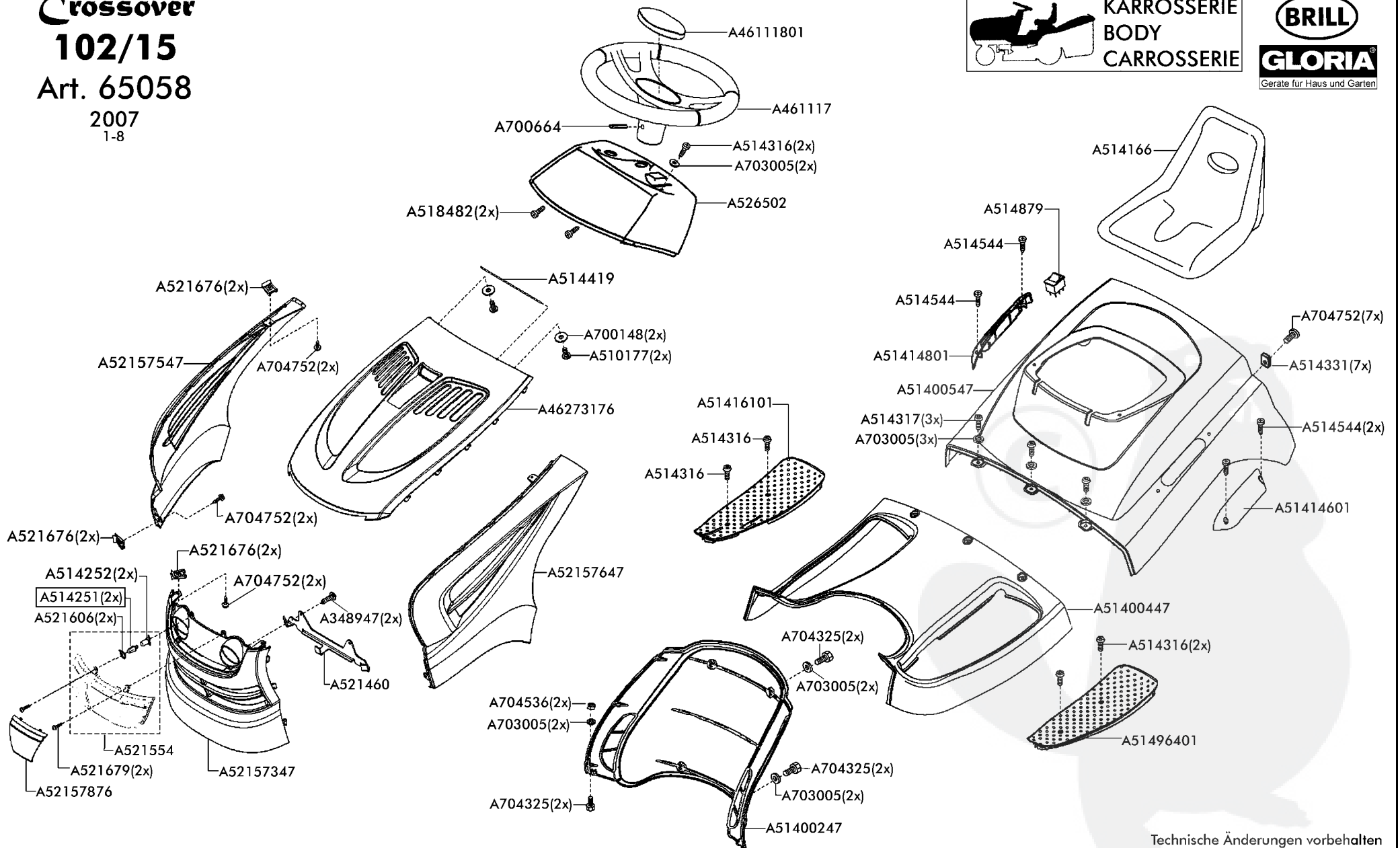
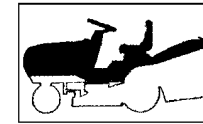

Technische Änderungen vorbehalten

2/22		RASENTRAKTOREN		Crossover	
2007		LAWN TRACTORS		102 / 15 - Art. 65058	
073802		Tracteurs de pelouse		Modell 2007	
Bild Nr. REF.N° POS.N°	BEST.-NR. PART.-N° N° d. PIECE	BEZEICHNUNG	DESCRIPTION	DÉSIGNATION	Qty.
1	A348947	SCHRAUBE PT-KB 60X20 1442	SCREW	ECROU	2
2	A461117	LENKRAD KPL	STEERING WHEEL	VOLANT	1
3	A46111801	ABDECKKAPPE FÜR LENKRAD R9005	STEERING CAP	BOUCHON	1
4	A51400447	ABDECKUNG, UNTEN	LOWER COVER PLATE	COUVRE	1
5	A51416101	TRITTPLATTE RECHTS R9005	RIGHT FOOTBOARD	COUVRE MARCHEPIED DROITE	1
6	A51414601	ABDECKUNG SCHALTGETRIEBE R9005	BEZEL R9005	BANDEAU R9005	1
7	A46273176	OBERTEIL HAUBE OEM-BRILL R7016	UPPER HOOD R7016	CAPOT R7016	1
8	A510177	SHR PT-KB 60 X14 1411	SCREW KB 60 X14 1411	VIS KB 60 X14 1411	2
9	A51400247	KONSOLE MOTORHAUBE R6001	CENTRAL DASHBOARD	SUPPORT TABLEAU CENTR.	1
10	A51400547	MITTELKONSOLE HINTEN R6001	REAR COVER	COUVRE	1
11	A51414801	ABDECKUNG HÖHENVERSTELLUNG R9005	BEZEL R9005	BANDEAU R9005	1
12	A514166	SITZ 1	SEAT	SIÈGE	1
13	A514251	LAMPE XENON 6W	FARILAMP XENON 6W	LAMPE XENON 6W	2
14	A514252	LAMPENFASSUNG TRAKTOR	LAMP HOLDER	DOUILLE DE LAMPE	2
15	A514316	SCHRAUBE SFS-TAPT 6X12 2019 A3R	SCREW	VIS	6
16	A514317	SCHRAUBE SFS.TAPT6X16 2019 A3R	SCREW	ECROU	3
17	A514331	BLECHMUTTER 4.8 FORM 1 VZ	NUT	ECROU	7
18	A514419	FEDERSTAHL DRAHT VERZ	ROD	BARRE	1
19	A514544	SCHRAUBE PT-KB60X30 1411A3R	SCREW	ECROU	4
20	A514879	SCHALTER JXA2Z00B-AZC00-000-XA	SWITCH	BOUTON	1
21	A51496401	TRITTPLATTE LINKS 102 R9005	LEFT FOOTBOARD	COUVRE MARCHEPIED GAU.	1
22	A521460	SCHARNIERBLECH HAUBE	HOOD SUPPORT	CAPOT SUPPORT	1
23	A521554	SCHEINWERFER KPL HAUBE-4 XENON 6W	FLOOD LIGHT CARTRIDGE ASSY.	PHARE GARNITURE CPL.	1
24	A52157347	FRONTTEIL HAUBE R6001	FRONT HOOD GREEN	CAPOT VERT	1
25	A52157547	SEITENTEIL RECHTS HAUBE R6001	SIDE HOOD RIGHT	CAPOT DROITE	1
26	A52157647	SEITENTEIL LINKS HAUBE R6001	SIDE HOOD LEFT	CAPOT GAUCHE	1
27	A52157876	FRONTBLLENDE	COVER PLATE	GRILL	1
28	A521606	SCHLAUCHKLEMME "REFLEKTOR"	FAIR LED	FIXATION	2
29	A521676	SCHNAPPMUTTER NU 0921	NUT NU 0921	ECROU NU 0921	6
30	A521679	SCHRAUBE PT-KB 30X12 WN 5452	SCREW	VIS	2
31	A526502	BEDIENKONSOLE TAMP Y-SILBER	DASHBOARD TAMP Y-SILBER	TABLEAU DE BORD TAMP Y-SILBER	1
32	A700148	SCHEIBE 6,4 9021-ST VZ	WASHER	RONDELLE	1
33	A700664	SPANNHUELSE 8 X 60 1481	COLLET	DOUILLE	1
34	A703005	SCHEIBE 6,4 9021-ST A3S	WASHER	RONDELLE	11
35	A704325	SCHRAUBE 6X 40 933- 8.8A3S	SCREW	VIS	6
36	A704536	MUTTER 6KT 6 985- 8 A3B	NUT	ECROU	2
37	A704752	SCHRAUBE KO 4,8X16 ZZ-C7981VZ	SCREW	ECROU	13



KARROSSERIE
BODY
CARROSSERIE

BRILL

GLORIA
Garten für Haus und Garten



RAHMENSATZ & LENKGETRIEBE
CHASSIS & STEERING
CHASSIS & BARRE DE DIRECTION

Crossover

102 / 15 - Art. 65058

Modell 2007



Crossover 102/15 Art. 65058

2007
2-8

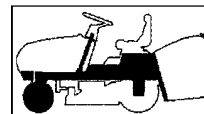

RAHMENSATZ & LENKGETRIEBE
CHASSIS & STEERING
CHASSIS & BARRE DE DIRECTION



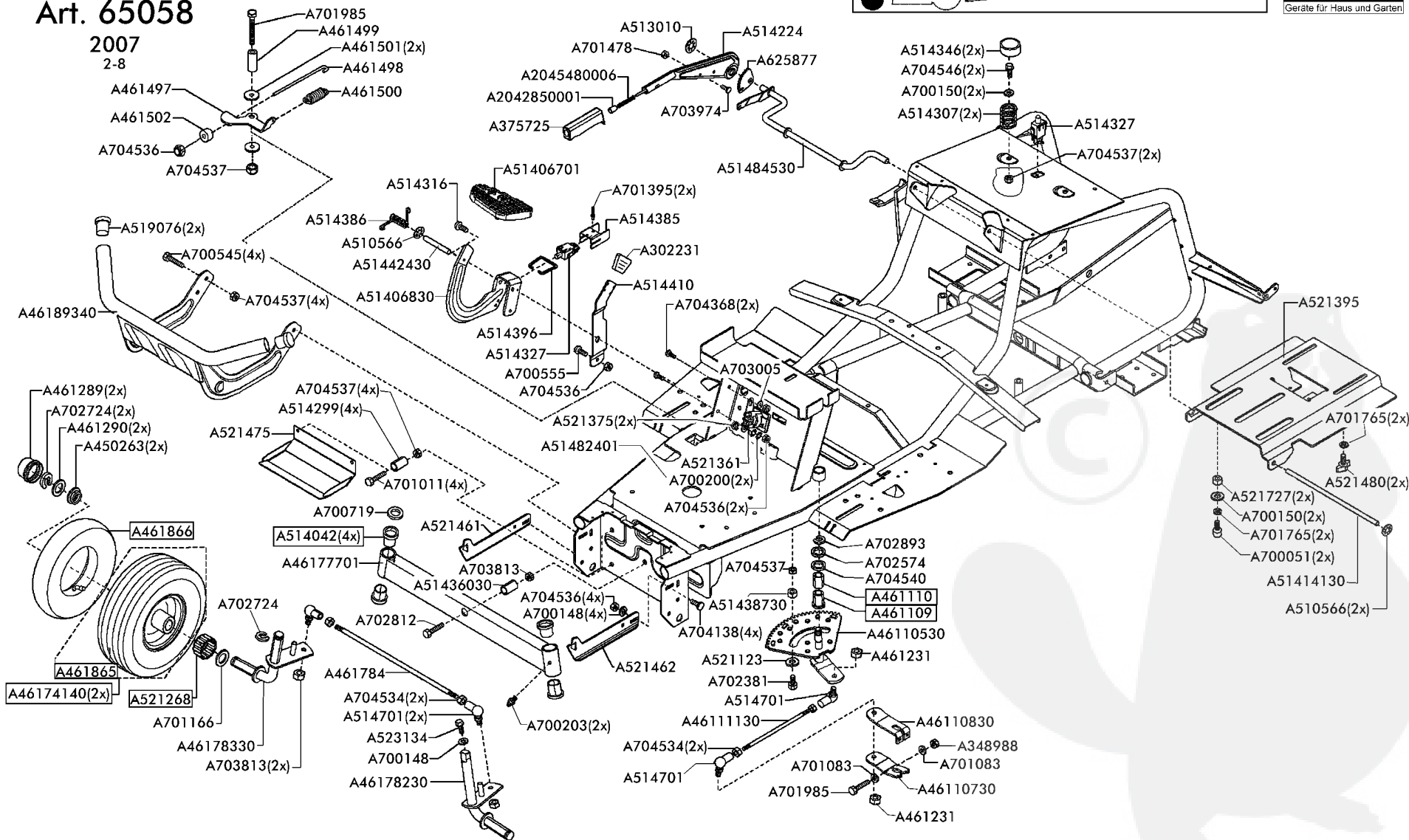

Geräte für Haus und Garten



Technische Änderungen vorbehalten

4/22		RASENTRAKTOREN		 RAHMENSATZ & LENKGETRIEBE CHASSIS & STEERING CHASSIS & BARRE DE DIRECTION	Crossover		1/3 	
2007		LAWN TRACTORS			102 / 15 - Art. 65058			 GLORIA <small>Garten für Haus und Garten</small>
073802		Tracteurs de pelouse			Modell 2007			
Bild Nr. REF.N° POS.N°	BEST.-NR. PART-N° N° d. PIECE	BEZEICHNUNG	DESCRIPTION	DÉSIGNATION	Qty.			
1	A2042850001	DRUCKKNOPF F. BR-HEBEL T	BUTTON	POUSSOIR	1			
2	A2045480006	FEDER F. HANDGRIFF T	SPRING	RESSORT	1			
3	A302231	KAPPE R9005	CAP	BONNET	1			
4	A348988	MUTTER SIC- BIW M 8 A3C- 8 MITTELGESICH	NUT	ECROU	1			
5	A375725	HANDGRIFF HOENENVERST. T	KNOB	POIGNEE	1			
6	A450263	BUCHSE TRAKTOR VORDERRAD	BUSH	DOUILLE	2			
7	A46110530	LENKSEGMENT GESCHW VERZ	SEGMENT	SEGMENT GUIDER	1			
8	A46110730	LENKHEBEL 2 TEILIG UNTEN VERZ	LOWER STEERING ARM	LEVIER GUIDER EN BAS	1			
9	A46110830	LENKHEBEL 2 TEILIG OBEN VERZ	UPPER STEERING ARM	LEVIER GUIDER EN HAUT	1			
10	A461109	BUNDBUCHSE LENKUNG	COLLAR BUSH	DOUILLE	1			
11	A461110	BUCHSE	BUSH	DOILLE	1			
12	A46111130	SCHUBSTANGE VERZ	STEERING ROD DIRECTION	LEVIER BARRE DE	1			
13	A461231	MUTTER SIC- BIW M10 A3B- 8	NUT	ECROU	2			
14	A461289	ABDECKKAPPE"TRAKTOR"	HUB COVER	COUVRE MOYEU	2			
15	A461290	SCHEIBE 42MM FÜR TRAKTOR	WASHER	RONDELLE	2			
16	A461497	WIPPE FÜR KUPPLUNG FAHRANTRIEB	ROCKER	BASCULE	1			
17	A461498	ZUGSTANGE FÜR KUPPLUNG FAHRANTRIEB	TENSION ROD	BARRE	1			
18	A461499	ROHR FÜR KUPPLUNG FAHRANTRIEB	TUBE FOR CLUTCH (DRIVE)	TUYAU EMBRAYAGE ENTR.D.ROUE	1			
19	A461500	ZUGFEDER FÜR KUPPLUNG FAHRANTRIEB	SPRING	RESSORT	1			
20	A461501	LAGERSCHEIBE FÜR KUPPLUNG FAHRANTRIEB	DISK	DISQUE	2			
21	A461502	KUGELFÜHRUNG FÜR KUPPLUNG FAHRANTR	GUIDANCE	GUIDAGE	1			
22	A46174140	VORDERRAD 15X6.00-6 BREIT KPL R9006	FRONT WHEEL 15X6.00-6	ROUE AVANT 15X6.00-6	2			
23	A46177701	VORDERACHSE 15" GESCHW R9005	FRONT AXLE 15"	AXE AVANT	1			
24	A46178230	ACHSSCHENKEL LINKS 15" GESCHW VERZ	LEFT STUB AXLE	FUSEAU GAUCHE	1			
25	A46178330	ACHSSCHENKEL RECHTS 15" GESCHW VERZ	RIGHT STUB AXLE	FUSEAU DROITE	1			
26	A461784	SPURSTANGE 15"	TIE ROD	TIRANT	1			
27	A461865	REIFEN 15X6,00-6 2PR	SHOE 15X6,00-6 2PR	PNEU 15X6,00-6 2PR	2			
28	A461866	SCHLAUCH 15X6,00-6 TR13	HOSE	TUYAU	2			
29	A46189340	STOSSSTANGE 30 MM LANG R9006 BRILL	BUMPER R9006	PAPE-CHOCS	1			
30	A510566	SCHNELLBEFESTIGER 8SXN26	CROWN FASTENER	FIXATEUR A COURONNE	3			
31	A513010	SCHNELLBEFESTIGER 16 SXN27	CROWN FASTENER	FIXATEUR A COURONNE	1			
32	A514042	BUCHSE-ACHSSCHENKEL	BRASS	COUSSINET	4			
33	A51406701	PEDALAUFLAGE BREMSE UND KUPPL. R9005	CLAMP COVER FRONT	COUVRE ETRIER AVANT	1			
34	A51406830	PEDAL RECHTS VERZ	DRIVE PEDAL	PEDALE TRANSMISSION	1			
35	A514224	HEBEL KPL.HÖHENVERSTELLUNG	LEVER	LEVIER	1			
36	A51424130	BEFESTIGUNGSBÜGEL SCHALTUNG VERZ	PLATE	PLAQUE	1			
37	A514299	PENDELANSCHLAG VERZ	BLOCK	BLOC	4			
38	A514307	DRUCKFEDER FÜR SITZ	SPRING	RESSORT	2			

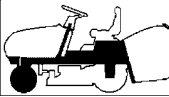
5/22		RASENTRAKTOREN		 RAHMENSATZ & LENKGETRIEBE CHASSIS & STEERING CHASSIS & BARRE DE DIRECTION	Crossover		102 / 15 - Art. 65058 Modell 2007	2/3	 
2007		LAWN TRACTORS							
073802		Tracteurs de pelouse							
Bild Nr. REF.N° POS.N°	BEST.-NR. PART.-N° N° d. PIECE	BEZEICHNUNG	DESCRIPTION	DÉSIGNATION	Qty.				
39	A514316	SCHRAUBE SFS-TAPT 6X12 2019 A3R	SCREW	VIS	1				
40	A514327	DRUCKSCHALTER	PRESS SWITCH	INTERRUPTEUR À PRESSION	2				
41	A514346	ABDECKKAPPE D-35 RAL9005	HOOD	PROTECTEUR	2				
42	A51436030	LAGERBUCHSE-VORDERACHSE VERZ	SPACER	ENTRETOISE	1				
43	A514385	SCHALTERHALTER	SUPPORT	SUPPORT	1				
44	A514386	DREHFEDER RECHTS	SPRING	RESSORT	1				
45	A51438730	DISTANZBUCHSE VERZ	SPACER	BAGUE D'ÉCARTEMENT	1				
46	A514396	BÜGEL	CONNECTING PLATE	PAQUE DE CONNEXION	1				
47	A514410	FESTSTELLFEDER RECHTS	SPRING	RESSORT	1				
48	A51442430	LAGERBOLZEN PEDAL VERZ.	PIN	PIVOT	1				
49	A514701	WINKELGELENK CS16-M10+SIC	JOINT	JOINT	4				
50	A5148240110	RAHMEN 102CM R9005 NACHARBEIT	CHASSIS 102 R9005	CHASSIS 102 R9005	1				
51	A51484530	LAGERWELLE GESCHW VERZ	SHAFT	ARBRE	1				
52	A519076	ROHRSTOPFEN FÜR ROHR 30X2	COVER	BOUCHER	2				
53	A521123	SCHEIBE D50X5	WASHER	RONDELLE	1				
54	A521268	ROLLENLAGER 20X30X55	ROLLER BEARING	COUSSINET	2				
55	A521361	STARTERRELAIS 12V/100AMPER	STARTER RELAY	RELAIS D'ALL.	1				
56	A521375	SKT-MUTTER+SPERRZ.1/4"-20 UN 8.8	NUT	ECROU	2				
57	A521395	VERSTELLKONSOLE SITZ GENIETET	PLATE	PLAQUE	1				
58	A521461	ANBINDUNGSBLECH RECHTS	STIFFENING RIGHT	RENFORCEMENT DROITE	1				
59	A521462	ANBINDUNGSBLECH LINKS	BRACKET LEFT	RENFORCEMENT GAUCHE	1				
60	A521475	WÄRMELEITBLECH UNTEN H-4 UND 2 ZYLINDER	LOWER HEAT GUARD	DÉFLECTEUR CHALEUR EN BAS	1				
61	A521480	FLÜGELSCHRAUBE M8X20	SCREW	VIS	2				
62	A521727	DISTANZBUCHSE	SPACER	ENTRETOISE	2				
63	A523134	SFS-TAPT.M6X12 2021 A2K	SCREW	VIS	1				
64	A625877	SEGMENT "FE/ZN 12 F"	STEERING SHAFT	ARBRE DIRECTION	1				
65	A700051	SCHRAUBE 8X 20 912- 8.8 VZ	SCREW 8X 20 912- 8.8 VZ	VIS 8X 20 912- 8.8 VZ	2				
66	A700148	SCHEIBE 6,4 9021-ST VZ	WASHER	RONDELLE	5				
67	A700150	SCHEIBE 8,4 9021-ST VZ	WASHER	RONDELLE	4				
68	A700200	SCHEIBE FÄCHER- J 6,4 6798 VZ	WASHER	RONDELLE	2				
69	A700203	NIPPEL AS 6X1 KEG 71412	GREASE DISPENSER	GRAISSEUR	2				
70	A700545	SCHRAUBE 8X 16 933- 8.8VZ	SCREW 8X 16 933- 8.8VZ	VIS 8X 16 933- 8.8VZ	4				
71	A700555	SCHRAUBE 6X 16 933- 8.8VZ	SCREW	VIS	1				
72	A700719	SCHEIBE 21 433 VZ	WASHER	RONDELLE	1				
73	A701011	SCHRAUBE 8X 50 933- 8.8VZ	SCREW	VIS	4				
74	A701083	SCHEIBE 8,4VZ7349"701083"	WASHER	RONDELLE	1				
75	A701166	SCHEIBE PA 20X28X0,5 988	WASHER	RONDELLE	1				
76	A701395	BLINDNIET 4,0X 8	RIVET	RIVET	2				

6/22		RASENTRAKTOREN		 RAHMENSATZ & LENKGETRIEBE CHASSIS & STEERING CHASSIS & BARRE DE DIRECTION	Crossover		3/3  
2007		LAWN TRACTORS			102 / 15 - Art. 65058		
073802		Tracteurs de pelouse			Modell 2007		
Bild Nr. REF.N° POS.N°	BEST.-NR. PART-N° N° d. PIECE	BEZEICHNUNG	DESCRIPTION	DÉSIGNATION	Qty.		
77	A701478	MUTTER HUT 5 986- 8 VZ	NUT	ECROU	1		
78	A701765	SCHEIBE FÄCHER- A 8,4 6798 VZ	WASHER FÄCHER- A 8,4 6798 VZ	RONDELLE A 8,4 6798 VZ	4		
79	A701985	SCHRAUBE 8X 55 931- 8.8VZ	SCREW	VIS	1		
80	A702381	SCHRAUBE 8X 30 7991- 8.8 VZ	SCREW	VIS	1		
81	A702574	SCHEIBE PA 14X20X1,0 988 VZ	WASHER	RONDELLE	1		
82	A702724	SCHEIBE SICH 15 6799 VZ	WASHER	RONDELLE	3		
83	A702812	SHR10X 55 931- 8.8A3C	SCREW	VIS	1		
84	A702893	SCHEIBE SICH 10 6799 DAC	WASHER	RONDELLE	1		
85	A703005	SCHEIBE 6,4 9021-ST A3S	WASHER	RONDELLE	1		
86	A703813	MUTTER 6KT 10 985-10 A3B	NUT	ECROU	3		
87	A703974	SCHRAUBE 5X 20 965-4.8-H A3B	SCREW	VIS	1		
88	A704138	SCHRAUBE 6X 16 603- 4.6A3B	SCREW	ECROU	4		
89	A704368	SCHRAUBE 6X 18 933- 8.8A3C	SCREW	ECROU	2		
90	A704534	MUTTER 10 934- 8 A3B	NUT	ECROU	4		
91	A704536	MUTTER 6KT 6 985- 8 A3B	NUT	ECROU	8		
92	A704537	MUTTER 6KT 8 985- 8 A3B	NUT	ECROU	12		
93	A704540	SCHEIBE A 13 125-ST A3B	WASHER	RONDELLE	1		
94	A704546	SCHRAUBE 8X 20 933- 8.8A3B	SCREW	VIS	2		



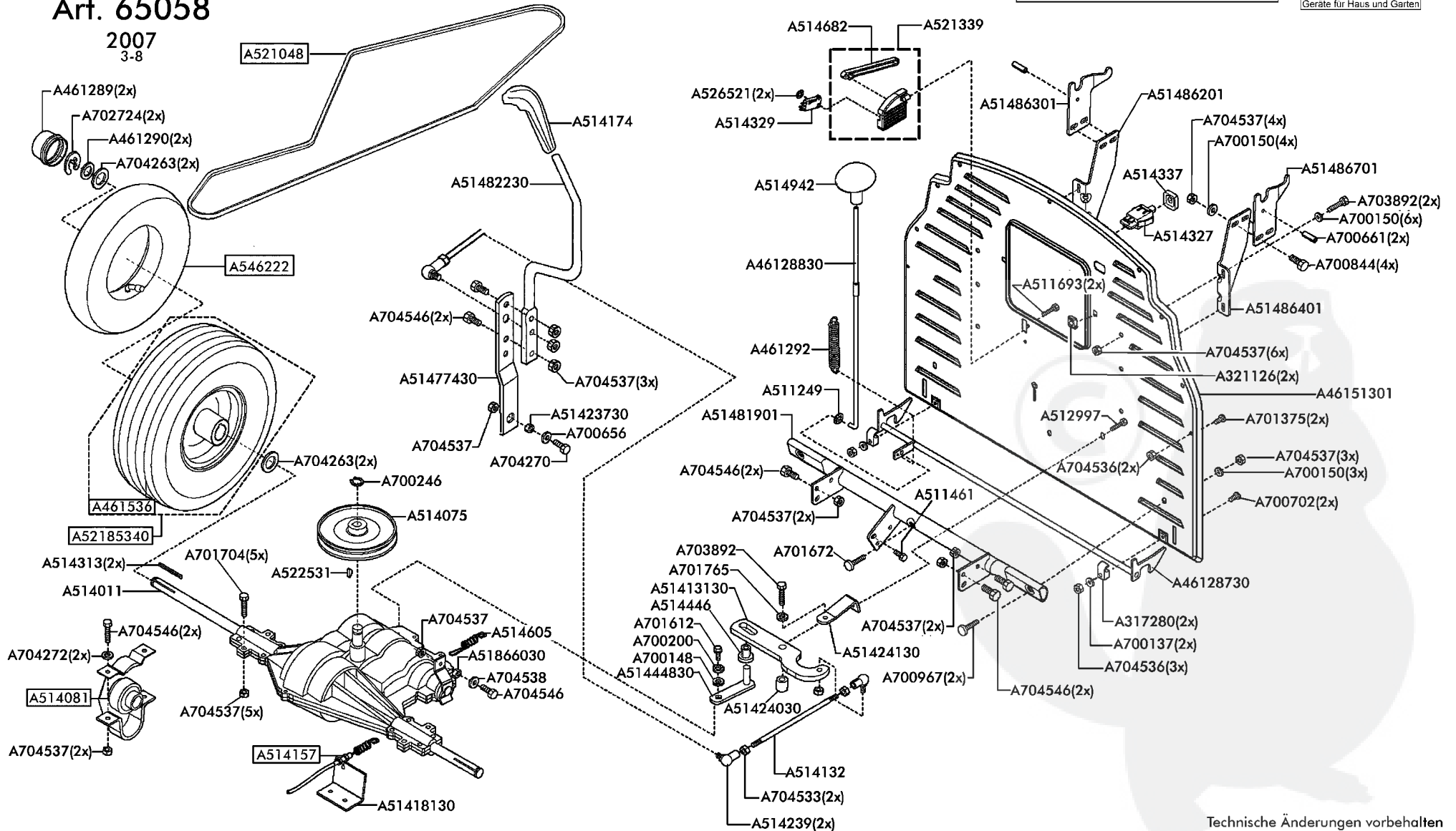

Crossover
102/15
Art. 65058
2007
 3-8

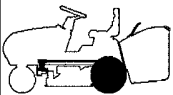

Technische Änderungen vorbehalten

8/22		RASENTRAKTOREN	 GETRIEBE TRANSMISSION TRANSMISSION	Crossover		 	
2007		LAWN TRACTORS		102 / 15 - Art. 65058			1/2
073802		Tracteurs de pelouse		Modell 2007			
Bild Nr. REF.N° POS.N°	BEST.-NR. PART.-N° N° d. PIECE	BEZEICHNUNG	DESCRIPTION	DÉSIGNATION	Qty.		
1	A317280	KABELSCHELLE	CABLE CLIP	COLLIER	2		
2	A321126	MUTTER KASTEN- M 6-ST GALVZ+PASSI	NUT M 6-ST GALVZ+PASSI	ECROU M 6-ST GALVZ+PASSI	2		
3	A46128730	BOXVERRIEGELUNG GESCHW VERZ	BOX LOCKING	BOX DISPOSITIF DE BLOCKAGE	1		
4	A46128830	VERRIEGELUNGSSTANGE VERZ	LOCKING ROD	BARRE DE BLOCKAGE	1		
5	A461289	ABDECKKAPPE"TRAKTOR"	HUB COVER	COUVRE MOYEU	2		
6	A461290	SCHEIBE 42MM FÜR TRAKTOR	WASHER	RONDELLE	2		
7	A461292	RÜCKHOLFEDER BOXVERRIEGELUNG	TENSION SPRING	RESSORT	1		
8	A46151301	RÜCKWAND 102 R9005	REAR PANEL	PANNEAU ARRIERE	1		
9	A461536	MANTEL FÜR REIFEN 18X8,50-8 2PR	SHOE 18X8,50-8 2PR	PNEU 18X8,50-8 2PR	2		
10	A511249	SCHNELLBEFESTIGER 7SXN26	CROWN FASTENER 7SXN26	FIXATEUR A COURONNE 7SXN26	1		
11	A511461	SCHRTAPT-EJOT8X16 1347A A3B	SCREW	VIS	1		
12	A511693	SCHRAUBE PT-KB 5X10 WN1411 A3B	SCREW	VIS	2		
13	A512997	SFS-TAPT 8X12 NR2021 A3C	SFS TAPT SCREW 8X12 NR2021 A3C	SFS TAPT VIS 8X12 NR2021 A3C	1		
14	A514011	SCHALTGETRIEBE 5-GANG MST 205-540 D	GEARBOX ASSY. MST 205-540 D	TRANSMISSION CPL MST 205-540 D	1		
15	A514075	KEILRIEMENSCHLEIBE GETRIEBE 5-GANG KPL	PULLEY ASSY	POULIE	1		
16	A514081	Y-STEHLAGER 3/4"	SUPPORT ASSY	SUPPORT CPL	1		
17	A51413130	ANSTEUERHEBEL SCHALTGETRIEBE VERZ	LEVER	LEVIER	1		
18	A514132	VERBINDUNGSSTANGE-SCHALTGETRIEBE	CONNECTION ROD	BARRE DE CONNECTION	1		
19	A514157	SCHALT-BOWDENZUG-BREMSE	BOWDEN CABLE	FIL	1		
20	A514174	SCHALTGRIF	KNOB	POIGNEE	1		
21	A51418130	WIDERLAGER BREMSE VERZ.	SUPPORT ASSY	SUPPORT CPL	1		
22	A51423730	DISTANZBUCHSE VERZ.	SPACER	ENTRETOISE	1		
23	A514239	WINKELGELENK C13SXN68/02R	JOINT	JOINT	2		
24	A51424030	DISTANZHÜLSE-SCHALTUNG VERZ	SPACER	DOUILLE	1		
25	A51424130	BEFESTIGUNGSBÜGEL SCHALTUNG VERZ	PLATE	PLAQUE	1		
26	A514313	PASSFEDER 3/16"X3/16"X2 1/4	FIT-IN KEY	GOUPILLE	2		
27	A514327	DRUCKSCHALTER	PRESS SWITCH	INTERRUPTEUR À PRESSION	1		
28	A514329	MIKROSCHALTER FÜLLSTANDANZEIGE	SWITCH	INTERRUPTEUR	1		
29	A514337	ABDECKTÜLLE FÜR DRUCKSCHALTER	COVER	COUVERCLE PROTECTION	1		
30	A514446	GLEITBUCHSE SCHALTUNG	SLIDING BUSHING	DOUILLE GLISSEMENT	1		
31	A51444830	GETRIEBESCHALTHEBEL GESCHW VERZ	LEVER	LEVIER	1		
32	A514605	RÜCKSTELLFEDER BREMSHEBEL	SPRING PLATE	RESSORT	1		
33	A514682	SCHALTHEBEL LANG	LEVER	LEVIER	1		
34	A51477430	FEDERBLECH SCHALTUNG VERZ	SPRING PLATE	MACARON RESSORT	1		
35	A51481901	VERSTEIFUNGSROHR SG GESCHW R9005	TUBE	CARNEAU	1		
36	A51482230	SCHALTHEBEL VERZ	LEVER	LEVIER	1		
37	A51486201	LAGERARM RECHTS UNTEN R9005	LOWER BEARING ARM RIGHT	PALIER BRAS DROITE EN BAS	1		
38	A51486301	LAGERARM RECHTS OBEN R9005	UPPER BEARING ARM RIGHT	PALIER BRAS DROITE EN HAUT	1		

9/22		RASENTRAKTOREN		 GETRIEBE TRANSMISSION TRANSMISSION	Crossover		102 / 15 - Art. 65058 Modell 2007	2/2  
2007		LAWN TRACTORS						
073802		Tracteurs de pelouse						
Bild Nr. REF.N° POS.N°	BEST.-NR. PART.-N° N° d. PIECE	BEZEICHNUNG	DESCRIPTION	DÉSIGNATION	Qty.			
39	A51486401	LAGERARM LINKS UNTEN R9005	LOWER BEARING ARM LEFT	PALIER BRAS GAUCHE EN BAS	1			
40	A51486701	LAGERARM LINKS OBEN R9005	UPPER BEARING ARM LEFT	PALIER BRAS GAUCHE EN HAUT	1			
41	A514942	VERRIEGELUNGSKNOPF R9005	ARRESTOR KNOB	BOUTON DE PRESSION ARRE.	1			
42	A51866030	DISTANZHÜLSE-TOTMANN VERZ	SPACER	DOUILLE	1			
43	A521048	FAHRANTRIEBSRIEMEN 102 SG	DRIVE BELT 102 SG	COURROIE 102 SG	1			
44	A521339	FÜLLSTANDSUMMERGEHÄUSE UND HEBEL	PROTECTION COVER & LEVER CPL	COUVERCLE PROTECTION & LEVIER CPL	1			
45	A52185340	HINTER-RAD 18X8.5-8 BREIT KPL R9006	REAR WHEEL CPL 18X8.5-8	ROUE ARRIERE CPL 18X8.5-8	2			
46	A522531	SCHEIBENFEDER 3/16"X3/4"	LOCK WASHER	DISQUE DE RESSORT	1			
47	A526521	SCHNELLBEFESTIGER 3SXN26	CROWN FASTENER	FIXATEUR A COURONNE	2			
48	A546222	SCHLAUCH 18"X8.5"-8 / 9.50-8 TR13	HOSE 18"X8.5"-8 / 9.50-8 TR13	TUYAU 18"X8.5"-8 / 9.50-8 TR13	2			
49	A700137	SCHEIBE A 6,4 125-ST VZ	WASHER	RONDELLE	2			
50	A700148	SCHEIBE 6,4 9021-ST VZ	WASHER	RONDELLE	1			
51	A700150	SCHEIBE 8,4 9021-ST VZ	WASHER	RONDELLE	13			
52	A700200	SCHEIBE FÄCHER- J 6,4 6798 VZ	WASHER	RONDELLE	1			
53	A700246	RING SICHT 16X1 471	CIRCLIP	CIRCLIPS	1			
54	A700656	FED TEL 28 X10,2X1,25 2093	DISK SPRING	DISQUE	1			
55	A700661	HUEL SPAN 6 X 20 1481	BUSHING	DOUILLE	2			
56	A700702	SCHRAUBE 6X 25 933- 8.8VZ	SCREW	VIS	2			
57	A700844	SCHRAUBE 8X 20 603- 4.6VZ	SCREW	VIS	4			
58	A700967	SCHRAUBE 8X 35 603- 4.6VZ	SCREW	VIS	2			
59	A701375	SCHRAUBE 6X 12 7985- 4.8-H VZ	SCREW 8X 25 933- 8.8A3B	VIS 8X 25 933- 8.8A3B	2			
60	A701612	SCHR SKT UNF 1/ 4"X12	SCREW UNF 1/ 4"X12	VIS UNF 1/ 4"X12	1			
61	A701672	SCHRAUBE	SCREW	VIS	1			
62	A701704	SCHRAUBE 8X 60 933- 8.8VZ	SCREW	VIS	5			
63	A701765	SCHEIBE FÄCHER- A 8,4 6798 VZ	WASHER FÄCHER- A 8,4 6798 VZ	RONDELLE A 8,4 6798 VZ	1			
64	A702724	SCHEIBE SICHT 15 6799 VZ	WASHER	RONDELLE	2			
65	A703892	SCHRAUBE 8X 45 933- 8.8A3B	SCREW	VIS	7			
66	A704263	SCHEIBE S 19X26X1,5 988A3C	WASHER	RONDELLE	4			
67	A704270	SCHRAUBE 8X25 EN ISO7380-10.9A3C	SCREW	VIS	1			
68	A704272	SCHEIBE PA 8X14X1,0 988	WASHER	RONDELLE	2			
69	A704533	MUTTER 8 934- 8 A3B	NUT	ECROU	2			
70	A704536	MUTTER 6KT 6 985- 8 A3B	NUT	ECROU	4			
71	A704537	MUTTER 6KT 8 985- 8 A3B	NUT	ECROU	29			
72	A704538	SCHEIBE A 8,4 125-ST A3B	WASHER	RONDELLE	1			
73	A704546	SCHRAUBE 8X 20 933- 8.8A3B	SCREW	VIS	9			

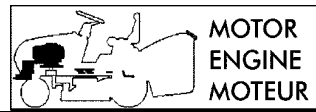

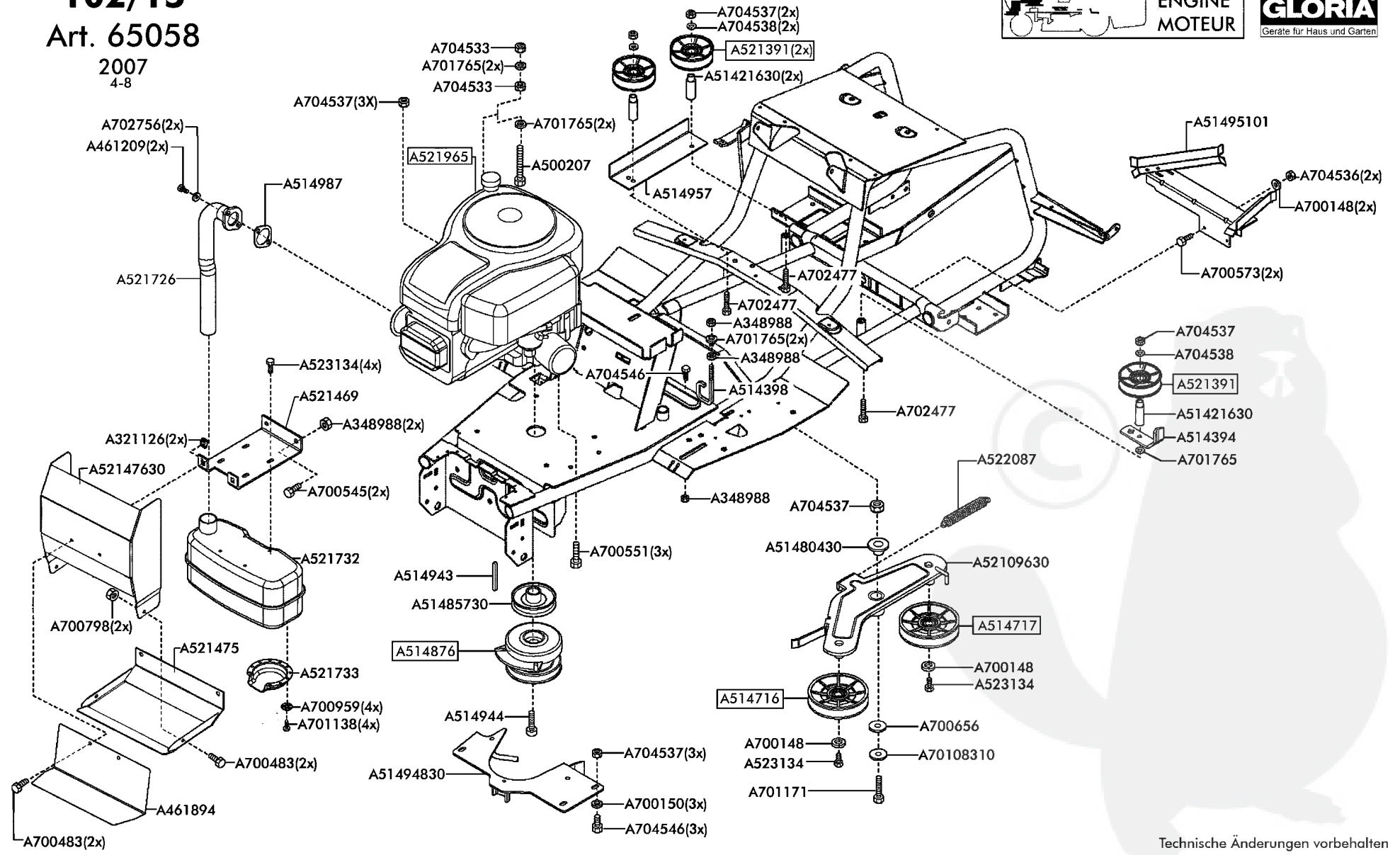
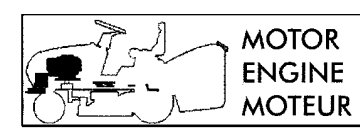

Crossover
102/15
Art. 65058
 2007
 4-8



Technische Änderungen vorbehalten

11/22	RASENTRAKTOREN	 MOTOR ENGINE MOTEUR	Crossover		1/2  
2007	LAWN TRACTORS		102 / 15 - Art. 65058		
073802	Tracteurs de pelouse		Modell 2007		
Bild Nr. REF.N° POS.N°	BEST.-NR. PART-N° N° d. PIECE	BEZEICHNUNG	DESCRIPTION	DÉSIGNATION	Qty.
1	A321126	MUTTER KASTEN- M 6-ST GALVZ+PASSI	NUT M 6-ST GALVZ+PASSI	ECROU M 6-ST GALVZ+PASSI	2
2	A348988	MUTTER SICHT- BIW M 8 A3C- 8 MITTELGESICHT	NUT	ECROU	5
3	A461209	SCHRAUBE ISKT UNC 5/16"X 3/4"A3B	SCREW	VIS	2
4	A461894	ABWEISBLECH	PLATE	PLATEAU	1
5	A500207	SCHRAUBE 8X 50 VERBUS RIPP A3R 8.8	SCREW	VIS	1
6	A51421630	ZENTRIERHÜLSE VERZ.	BUSHING	DOILLE	3
7	A514394	RIEMENFÜHRUNG VERZ	BELT GUIDE	GUIDAGE COURROIE	1
8	A514398	ÖSE-RIEMENFÜHRUNG MITTE	BELT GUIDE	GUIDAGE	1
9	A514716	SPANNROLLE INNEN +LAGER	TENSIONER INSIDE ASSY	ROUE SERRAGE	1
10	A514717	SPANNROLLE AUSSEN+LAGER	TENSION ROLL ASSY. OUTSIDE	ROUE SERRAGE À L'EXTÉRIEUR	1
11	A51480430	DISTANZBUCHSE WIPPE VERZ	SPACER	ENTRETOISE	1
12	A51485730	ANTRIEBSSEGMENT BBC 102 GESCHW VERZ	PULLEY	POULLIE	1
13	A514876	ELEKTR. KUPPLUNG BBC-102 I-5217-4 E	ELECTR. CLUTCH ASSY BBC-102 I-5217-4 E	EMBRAYAGE ÉLECTROMAGNETIQUE BBC-102 I	1
14	A514943	PASSFEDER 1/4"X1/4"X1"A	FIT-IN KEY	GOUPILLE	1
15	A514944	SCHRAUBE UNF 7/16"X3" 10.9	SCREW	VIS	1
16	A51494830	RIEMENFÜHRUNG FAHRANTRIEB GESCHW VERZ	BELT GUIDE	GUIDE DE COURROIE	1
17	A51495101	RIEMENFÜHRUNG HD102 GESCHW R9005	BELT GUIDE	GUIDAGE COURROIE	1
18	A514957	FÜHRUNGSBLECH 5-GANG 102	PLATE	GUIDAGE	1
19	A514987	FLANSCHDICHTUNG B&S 27229	FLANGE SEAL	JOINT	1
20	A52109630	SPANNROLLENWIPPE D16 GESCHW VERZ	LEVER D16	LEVIER D16	1
21	A521391	UMLENKROLLE ALU+LAGER	PULLEY ASSY	POULIE GUIDAGE CPL	3
22	A521469	AUSPUFFHALTEBLECH	SUPPORT	SUPPORT	1
23	A521475	WÄRMELEITBLECH UNTEN H-4 UND 2 ZYLINDER	LOWER HEAT GUARD	DÉFLECTEUR CHALEUR EN BAS	1
24	A52147630	LUFTLEITBLECH 2-ZYLINDER VERZ	AIR GUIDE	DÉFLECTEUR	1
25	A521726	KRÜMMER B&S 14,5/16,5/17 GESCHW	EXHAUST CONNECTING TUBE B&S 14,5/16,5/17	TUBE DE CONNEXION B&S 14,5/16,5/17	1
26	A521732	AUSPUFF B&S P 498984	MUFFLER	SILENCEUX	1
27	A521733	DEFLECTOR B&S P 222573	DEFLECTOR	DEFLECTEUR	1
28	A521965	MOTOR B&S 14.5HP IC OHV AVS	MOTOR B&S 14.5HP IC OHV AVS	MOTOR B&S 14.5HP IC OHV AVS	1
29	A522087	ZUGFEDER-BBC	SPRING	RESSORT	1
30	A523134	SFS-TAPT.M6X12 2021 A2K	SCREW	VIS	6
31	A700148	SCHEIBE 6,4 9021-ST VZ	WASHER	RONDELLE	4
32	A700150	SCHEIBE 8,4 9021-ST VZ	WASHER	RONDELLE	3
33	A700483	SCHRAUBE 6X 12 933- 8.8VZ	SCREW	VIS	4
34	A700545	SCHRAUBE 8X 16 933- 8.8VZ	SCREW 8X 16 933- 8.8VZ	VIS 8X 16 933- 8.8VZ	2
35	A700551	SCHRAUBE 8X 35 933- 8.8A3C	SCREW	VIS	3
36	A700573	SCHRAUBE 6X 20 603- 4.6VZ	SCREW	VIS	2
37	A700656	FED TEL 28 X10,2X1,25 2093	DISK SPRING	DISQUE	1

12/22		RASENTRAKTOREN		 MOTOR ENGINE MOTEUR		Crossover		  <small>Gloria für Pfand und Garten</small>	
2007		LAWN TRACTORS				102 / 15 - Art. 65058			
073802		Tracteurs de pelouse				Modell 2007			
Bild Nr. REF.N° POS.N°	BEST.-NR. PART-N° N°d. PIECE	BEZEICHNUNG	DESCRIPTION	DÉSIGNATION	Qty.				
38	A700798	MUTTER 6KT 6 980-V- 8	NUT	ECROU	2				
39	A700959	SHB FÄCHER- A 4,3 6798 VZ	WASHER	RONDELLE	4				
40	A701011	SCHRAUBE 8X 50 933- 8.8VZ	SCREW	VIS	1				
41	A70108310	SCHEIBE 8,4VZ7349"701083"	WASHER	RONDELLE	1				
42	A701138	SCHRAUBE ST4,2X13 -C-H7981 VZ	SCREW	VIS	4				
43	A701171	SCHRAUBE 8X 30 933- 8.8VZ	SCREW	VIS	1				
44	A701765	SCHEIBE FÄCHER- A 8,4 6798 VZ	WASHER FÄCHER- A 8,4 6798 VZ	RONDELLE A 8,4 6798 VZ	7				
45	A702477	SCHRAUBE 8X 80 931- 8.8VZ	SCREW	VIS	3				
46	A702756	SCHEIBE SICH SCHNORR S 8 MECHANVZ	WASHER	RONDELLE	2				
47	A704533	MUTTER 8 934- 8 A3B	NUT	ECROU	2				
48	A704536	MUTTER 6KT 6 985- 8 A3B	NUT	ECROU	2				
49	A704537	MUTTER 6KT 8 985- 8 A3B	NUT	ECROU	10				
50	A704538	SCHEIBE A 8,4 125-ST A3B	WASHER	RONDELLE	3				
51	A704546	SCHRAUBE 8X 20 933- 8.8A3B	SCREW	VIS	4				



Crossover
102/15
Art. 65058
 2007
 5-8

**SCHNEIDWERK
 CUTTING PLATE
 PLATEAU DE COUPE**

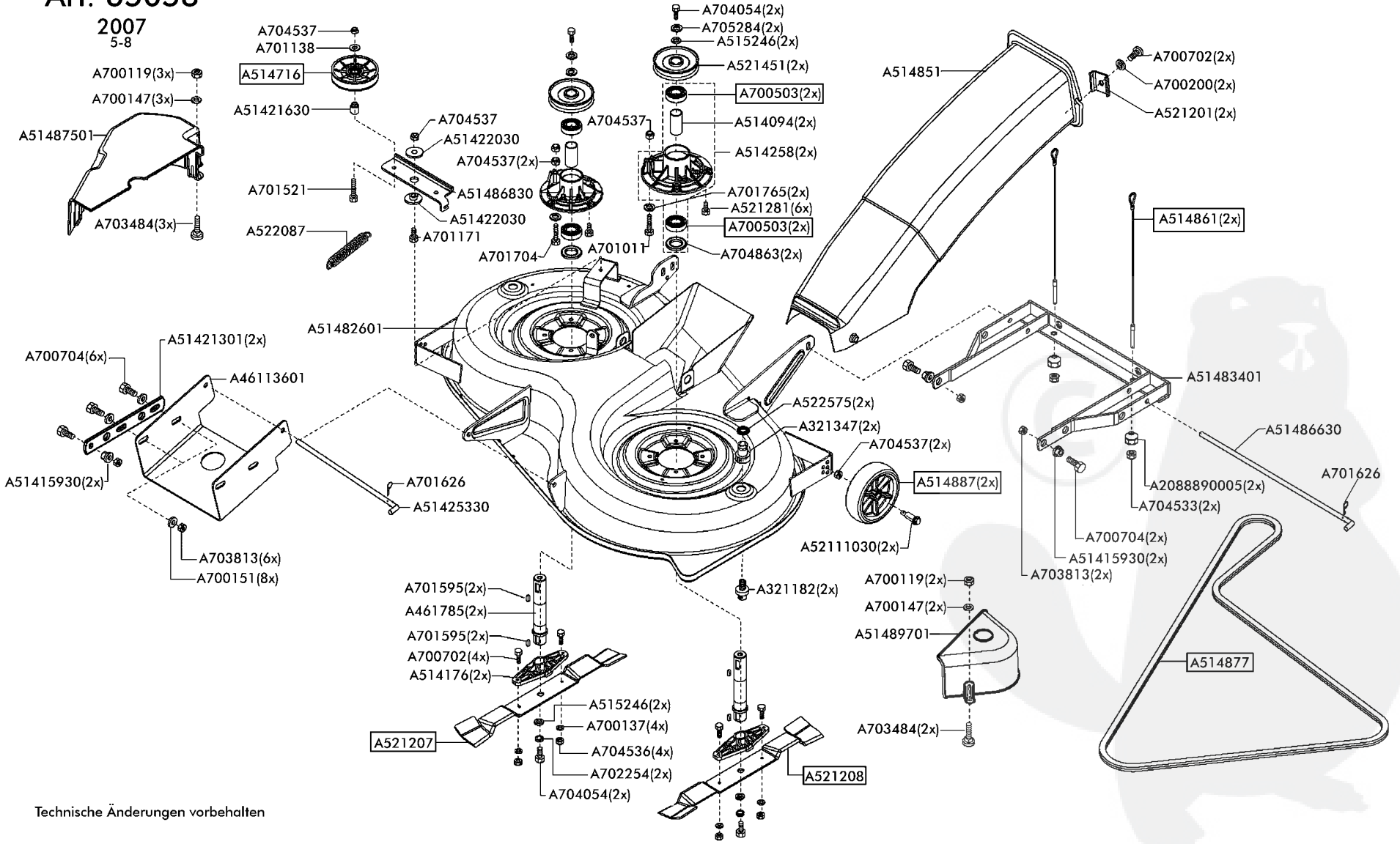

Technische Änderungen vorbehalten

14/22	RASENTRAKTOREN		SCHNEIDWERK CUTTING PLATE PLATEAU DE COUPE	Crossover	
2007	LAWN TRACTORS			102 / 15 - Art. 65058	1/2 
073802	Tracteurs de pelouse			Modell 2007	
Bild Nr. REF.N° POS.N°	BEST.-NR. PART.-N° N° d. PIECE	BEZEICHNUNG	DESCRIPTION	DÉSIGNATION	Qty.
1	A2088890005	KUGELMUTTER M8	NUT	ECROU	2
2	A321182	SPÜLDÜSE R1/2"	WATER HOSE CONNECTION	RACCORD TUYAU D'EAU	2
3	A321347	ANSCHLUSS R1/2"	TUBE ADAPTER R1/2"	ADAPTER TUYAU R1/2"	2
4	A46113601	MÄHDECKAUFHÄNGUNG VORNE R9005	CUTTING PLATE SUPPORT FRONT	PLATEAU SUSPENSION L'AVANT	1
5	A461785	MESSERWELLE TRAKTOR VERZ	BLADE SHAFT	ABRE	2
6	A514094	DISTANZBUCHSE-1	SPACER	ENTRETOISE	2
7	A51415930	DISTANZSCHEIBE VERZ	SPACER	ENTRETOISE	4
8	A514176	MESSERHALTER	BLADE FLANGE	BRIDE	2
9	A51421301	SCHENKEL-VORNE HÖHENVERSTELLUNG R9005	SUPPORT	SUPPORT	2
10	A51421630	ZENTRIERHÜLSE VERZ.	BUSHING	DOILLE	1
11	A51422030	DISTANZSCHEIBE VERZ	SPACER	ENTRETOISE	2
12	A51425330	ABSTECKSTANGE VERZ.	ROD	BARRE	1
13	A514258	LAGERBOCK KPL.	BLADE FLANGE ASSY. CPL	ENS. BRIDE POUR LAME CPL	2
14	A514716	SPANNROLLE INNEN +LAGER	TENSIONER INSIDE ASSY	ROUE SERRAGE	1
15	A51483401	AUFHÄNGUNG HINTEN 102 GESCHW R9005	REAR FRAME	SUSPENSION ARRIÈRE 102	1
16	A514851	AUSWURFKANAL TRAKTOR 102	FUNNEL ASSY	BUSE EJECTER CPL	1
17	A514861	DRAHTSEIL	STEEL WIRE ROPE	CABLE D'ACIER	2
18	A51486630	ABSTECKSTANGE HINTEN VERZ	ROD	BARRE	1
19	A51486830	SPANNWIPPE BBC VZKT	SUPPORT	SUPPORT	1
20	A51487501	ABDECKUNG MÄHANTRIEB RECHTS R9005	BELT COVER RIGHT R9005	BARRIÈRE DROITE CPL	1
21	A514877	MÄHANTRIEBSRIEMEN 102	V-BELT 102	COURROIE 102	1
22	A514887	RAD 125 R9005	WHEEL 125 CPL	ROUE CPL 125	2
23	A51489701	ABDECKUNG MÄHANTRIEB LINKS R9005	BELT COVER LEFT	BARRIÈRE GAUCHE CPL	1
24	A515246	SCHEIBE 30/10,5 X 5	WASHER	RONDELLE	4
25	A52111030	RADBOLZEN 102 VERZ	WHEEL BOLT	BOULLON ROUE	2
26	A521201	FIXIERUNGSSCHEIBE 102	FIXING PLATE	PLATEAU FIXATION	2
27	A521207	FLÜGELMESSER RECHTS TR-102	WING BLADE RIGHT 102	LAME DROITE 102	1
28	A521208	FLÜGELMESSER LINKS TR-102	WING BLADE LEFT 102	LAME GAUCHE 102	1
29	A521281	SCHRAUBE-TAPT 8X25 SPERRZ.A3S	SCREW	VIS	6
30	A521451	RIEMENSCHLEIBE VERSCHRAUBT 102 KPL	PULLEY ASSY	POULIE	2
31	A522087	ZUGFEDER-BBC	SPRING	RESSORT	1
32	A522575	O-RING D10,78X2,62 NBR	O-RING	O-RING	2
33	A700119	MUTTER 6KT 5 985- 8 VZ	NUT	ECROU	5
34	A700137	SCHEIBE A 6,4 125-ST VZ	WASHER	RONDELLE	4
35	A700147	SCHEIBE 5,3 9021-ST VZ	WASHER	RONDELLE	5
36	A700151	SCHEIBE 10,5 9021-ST VZ	WASHER	RONDELLE	8
37	A700200	SCHEIBE FÄCHER- J 6,4 6798 VZ	WASHER	RONDELLE	2

15/22	RASENTRAKTOREN		SCHNEIDWERK	Crossover	
2007	LAWN TRACTORS		CUTTING PLATE	102 / 15 - Art. 65058	
073802	Tracteurs de pelouse		PLATEAU DE COUPE	Modell 2007	
Bild Nr. REF.N° POS.N°	BEST.-NR. PART-N° N° d. PIECE	BEZEICHNUNG	DESCRIPTION	DÉSIGNATION	Qty.
38	A700503	KUGELLAGER 6205 2RS 625	BALL BEARING	ROULEMENT À BILLES	4
39	A700702	SCHRAUBE 6X 25 933- 8.8VZ	SCREW	VIS	6
40	A700704	SCHRAUBE10X 30 933- 8.8VZ	SCREW	VIS	9
41	A701011	SCHRAUBE 8X 50 933- 8.8VZ	SCREW	VIS	1
42	A701138	SCHRAUBE ST4,2X13 -C-H7981 VZ	SCREW	VIS	1
43	A701171	SCHRAUBE 8X 30 933- 8.8VZ	SCREW	VIS	1
44	A701521	SCHRAUBE 8X 40 933- 8.8VZ	SCREW	VIS	1
45	A701595	PASSFEDER 8X7X20 6885	FIT-IN KEY	GOUPILLE	4
46	A701626	FEDERSTECKER - 2,5 11024 VZ	COTTER PIN	GOUPILLE	2
47	A701765	SCHEIBE FÄCHER- A 8,4 6798 VZ	WASHER FÄCHER- A 8,4 6798 VZ	RONDELLE A 8,4 6798 VZ	2
48	A702254	SCHEIBE FÄCHER- A 10,5 6798 VZ	WASHER	RONDELLE	2
49	A703484	SCHRAUBE 5X 16 603- 4.6A3C	SCREW	VIS	5
50	A703813	MUTTER 6KT 10 985-10 A3B	NUT	ECROU	8
51	A704054	SCHRAUBE10X1,0 X 35 961- 8.8	SCREW	VIS	4
52	A704533	MUTTER 8 934- 8 A3B	NUT	ECROU	2
53	A704536	MUTTER 6KT 6 985- 8 A3B	NUT	ECROU	4
54	A704537	MUTTER 6KT 8 985- 8 A3B	NUT	ECROU	7
55	A704863	RWDR AS 30X 52X 5 3760-NB	WASHER	RONDELLE	2
56	A705284	TELLERFEDER 28 X10,2X1,5 2093	DISK SPRING	RESSORT D'ASSIETTE	2

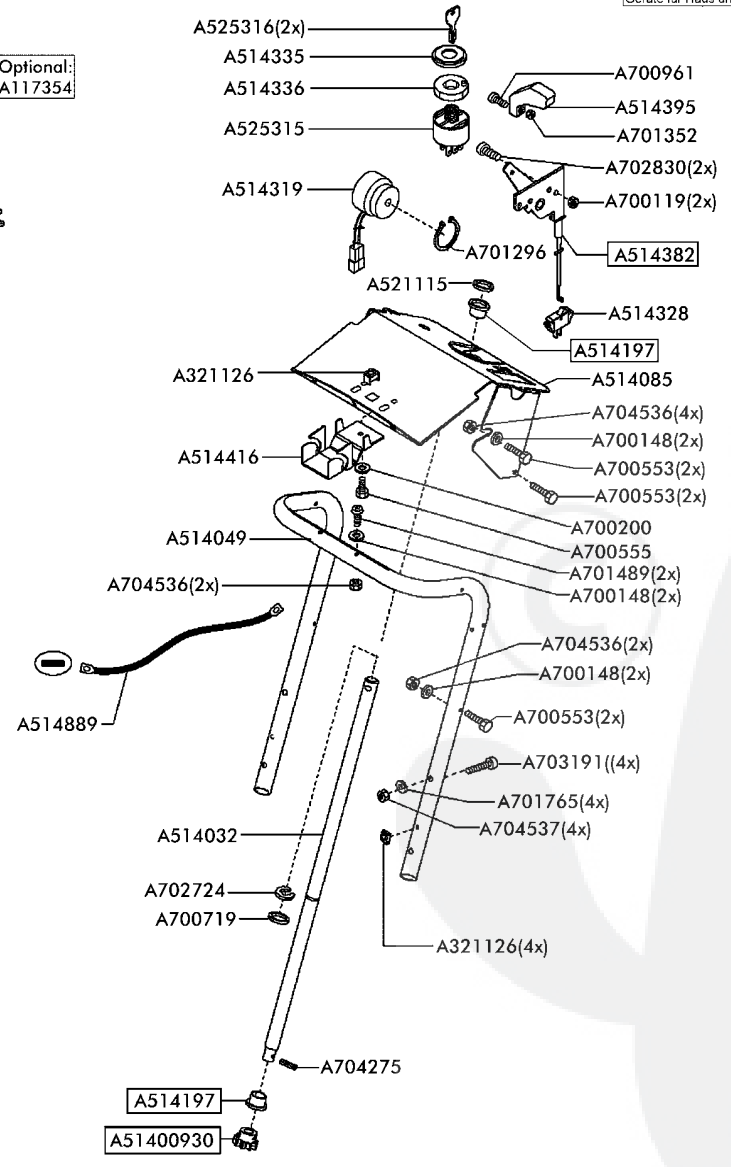
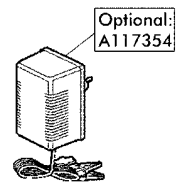
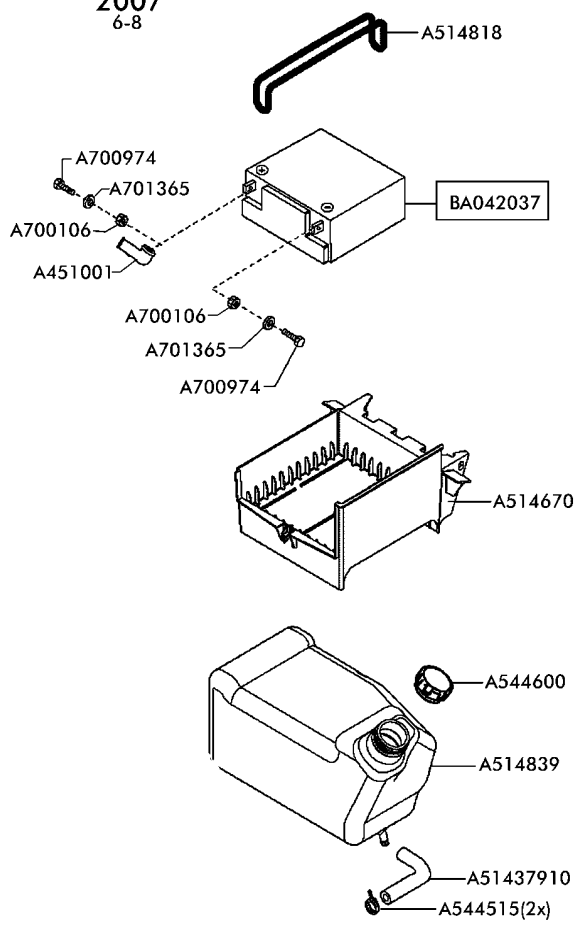

Crossover
 102/15
 Art. 65058
 2007
 6-8

TANK, BATTERIE & KOMPONENTEN
 TANK, BATTERY & COMPONENTS
 TANK, BATTERIE & COMPOSANTS

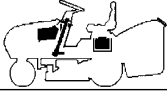

Technische Änderungen vorbehalten

17/22		RASENTRAKTOREN		 TANK, BATTERIE & KOMPONENTEN TANK, BATTERY & COMPONENTS TANK, BATTERIE & COMPOSANTS		Crossover		102 / 15 - Art. 65058		1/2		 	
2007		LAWN TRACTORS				Modell 2007							
073802		Tracteurs de pelouse											
Bild Nr. REF.N° POS.N°	BEST.-NR. PART.-N° N° d. PIECE	BEZEICHNUNG	DESCRIPTION	DÉSIGNATION	Qty.								
1	A117354	LADEGERÄT Crossover 12 V (optional)	CHARGER Crossover 12 V (optional)	CHARGEUR Crossover 12 V (optional)	1								
2	A321126	MUTTER KASTEN- M 6-ST GALVZ+PASSI	NUT	ECROU	4								
3	A451001	BATTERIEPOLABDECKUNG FÜR BATTERIE CSB	POL COVER	COUVERCLE DE PROTECTION	1								
4	A51400930	LENKUNGSRITZEL VERZ.	STEERING WHEEL	PIGNON	1								
5	A514032	LENKSÄULE VERZ	STEERING COLUMN	TUBE DE DIRECTION	1								
6	A514049	STÜTZHOLM	SUPPORT	SUPPORT	1								
7	A514085	STÜTZBLECH	SUPPORT	SUPPORT	1								
8	A514197	EP-BUNDBUCHSE	BUSH	DOILLE	2								
9	A514319	FÜLLSTANDSUMMER	BUZZER (GRASS BAG FULL)	BUZZER	1								
10	A514328	KIPPSCHALTER LICHT	ROCKER SWITCH I/O	INERRUPTEUR À BASCULE	1								
11	A514335	BEFESTIGUNGS MUTTER ZÜNDSCHLOSS	LOCK NUT	EMBOUT	1								
12	A514336	VERDREHSICHERUNG ZÜNDSCHLOSS	SAFETY NUT	EMBOUT	1								
13	A51437910	BENZINSCHLAUCH ZUSCHNITT	CONNECTING TUBE	TUBE DE CONNEXION	1								
14	A514382	GASFERNBEDIENUNG	ACCELERATOR	ACCELERATEUR	1								
15	A514395	BEDIENHEBEL	LEVER	LEVIER	1								
16	A514416	EINRASTBLECH	ENGAGE PLATE	PANNEAU ENCLIQUETER	1								
17	A514670	BATTERIEKASTEN	BATTERY INSERT	BATTERIE CAISSE	1								
18	A514818	BEFESTIGUNGSGUMMI	RUBBER BAND	ÉLASTIQUE	1								
19	A514839	BENZINTANK	TANK	RESERVOIR	1								
20	A514889	ZUSATZ MASSEKABEL	GROUND CABLE	CABLE	1								
21	A521115	SCHNELLBEFESTIGER20SXN26	CROWN FASTENER	FIXATEUR A COURONNE	1								
22	A525315	ZÜNDANLASSCHALTER RIDER	IGNITION SWITCH	INTERRUPTEUR DEMARR. /1	1								
23	A525316	ZÜNDSCHLÜSSEL	STARTING KEY	CLEF A DEMARRAGE	2								
24	A544515	SCHLAUCHKLEMME 14,5	TUBE CLAMP	BORNE	2								
25	A544600	TANKDECKEL KPL	TANK CAP	BOUCHON DE RÉSERVOIR	1								
26	A700106	MUTTER 5 934- 8 VZ	NUT	ECROU	2								
27	A700119	MUTTER 6KT 5 985- 8 VZ	NUT	ECROU	2								
28	A700148	SCHEIBE 6,4 9021-ST VZ	WASHER	RONDELLE	6								
29	A700200	SCHEIBE FÄCHER- J 6,4 6798 VZ	WASHER	RONDELLE	1								
30	A700553	SCHRAUBE 6X 40 933- 8.8VZ	SCREW	VIS	6								
31	A700555	SCHRAUBE 6X 16 933- 8.8VZ	SCREW	VIS	1								
32	A700719	SCHEIBE 21 433 VZ	WASHER	RONDELLE	1								
33	A700961	SCHRAUBE 4X 8 7985- 4.8-H VZ	SCREW	VIS	1								
34	A700974	SCHRAUBE 5X 16 933- 8.8VZ	SCREW	VIS	2								
35	A701296	SICHERUNGSRING 25X1,2 471	CIRCLIP	CIRCLIPS	1								
36	A701352	MUTTER 6KT 4 985- 8 VZ	NUT	ECROU	1								
37	A701365	SCHEIBE FÄCHER- A 5,3 6798 VZ	WASHER	RONDELLE	2								

18/22		RASENTRAKTOREN		 TANK, BATTERIE & KOMPONENTEN TANK, BATTERY & COMPONENTS TANK, BATTERIE & COMPOSANTS		Crossover		102 / 15 - Art. 65058		2/2 	
2007		LAWN TRACTORS				Modell 2007					
073802		Tracteurs de pelouse									
Bild Nr. REF.N° POS.N°	BEST.-NR. PART-N° N° d. PIECE	BEZEICHNUNG	DESCRIPTION	DÉSIGNATION	Qty.						
38	A701489	SCHRAUBE 6X 35 933- 8.8VZ	SCREW	VIS	2						
39	A701765	SCHEIBE FÄCHER- A 8,4 6798 VZ	WASHER FÄCHER- A 8,4 6798 VZ	RONDELLE FÄCHER- A 8,4 6798 VZ	4						
40	A702724	SCHEIBE SICH 15 6799 VZ	WASHER	RONDELLE	1						
41	A702830	SCHRAUBE 5X 12 7985- 4.8-H A3R	SCREW	VIS	2						
42	A703191	SCHRAUBE 8X 40 7991- 8.8A3C	SCREW	VIS	4						
43	A704275	SPANNSTIFT 6X24 7344	PIN	GOUPILLE	1						
44	A704536	MUTTER 6KT 6 985- 8 A3B	NUT	ECROU	8						
45	A704537	MUTTER 6KT 8 985- 8 A3B	NUT	ECROU	4						
46	BA042037	BATTERIE 12V-17Ah	BATTERY 12 V-17Ah	BATTERIE 12V-17Ah	1						



Crossover
102/15
Art. 65058
2007
7-8

GRASFANGSACK KPL.
GRASS CATCHER ASSY.
BAC COMPOSANTS

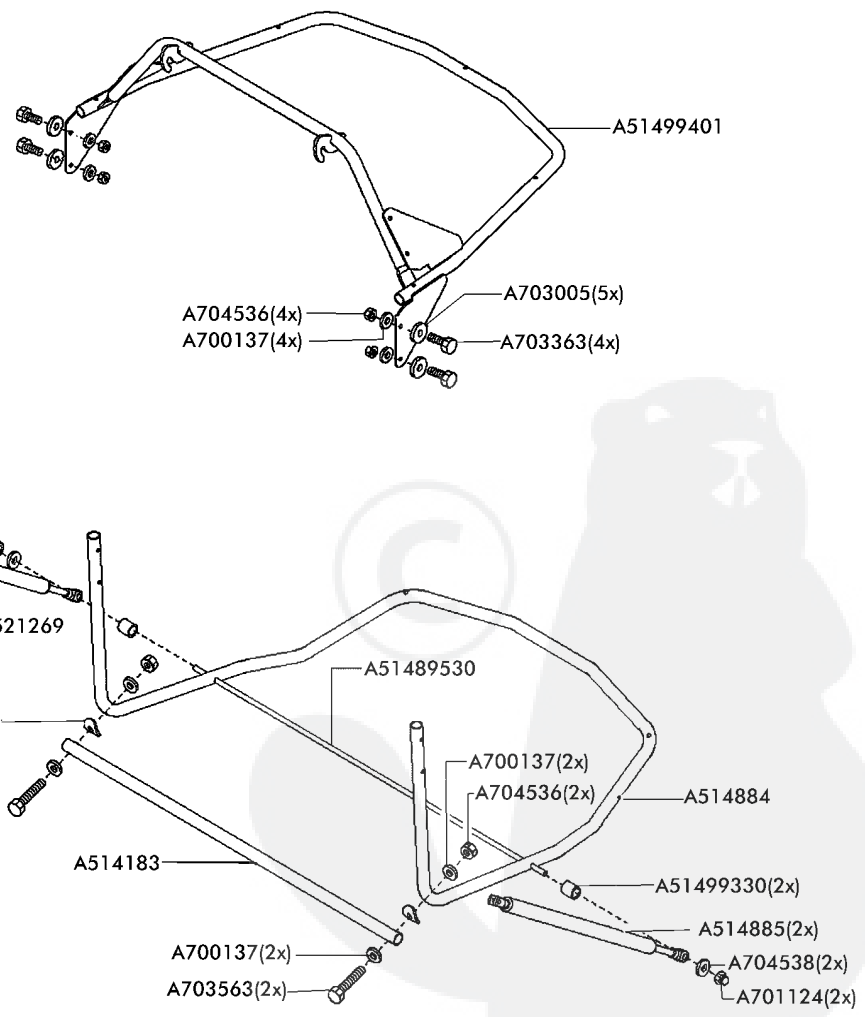
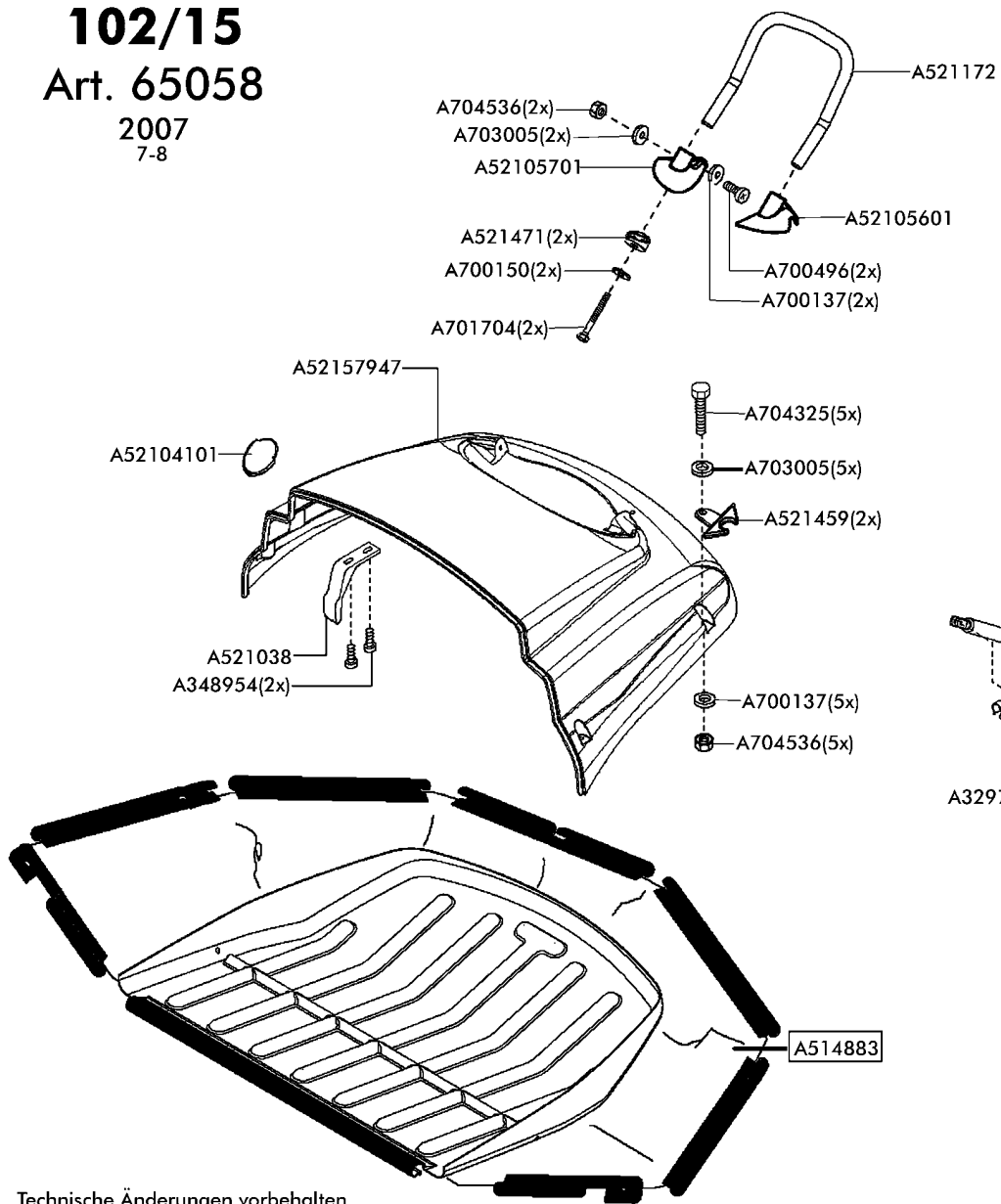
Technische Änderungen vorbehalten

20/22		RASENTRAKTOREN		 GRASFANGSACK KPL. GRASS CATCHER ASSY. BAC COMPOSANTS		Crossover		 	
2007		LAWN TRACTORS				102 / 15 - Art. 65058			
073802		Tracteurs de pelouse				Modell 2007			
Bild Nr. REF.N° POS.N°	BEST.-NR. PART-N° N° d. PIECE	BEZEICHNUNG	DESCRIPTION	DÉSIGNATION	Qty.				
1	A329761	SCHEIBE GEBOGEN H11	CURVED WASHER H11	RONDELLE COURBE	2				
2	A348954	SCHRAUBE.PT-KB 60X25 1411 VZ	SCREW	VIS	2				
3	A514183	QUERSTREBE BOX	ROD	TIGE	1				
4	A514883	GEWEBESACK 102 KPL	GRASS CATCHER BAG ASSY 102	BAC	1				
5	A514884	BOXROHR UNTEN 102	LOWER FRAME ASSY	CHASSIS INFERIEUR	1				
6	A514885	GASFEDER GF8-053550-130	GAS PRESSURE SPRING GF8-053550-130	RESSORT PNEUMATIQUE GF8-053550-130	2				
7	A51489530	BOXSTREBE TRAKTOR 102 VERZ	BOX BAR	BAC HAUBAN	1				
8	A51499330	DISTANZHÜLSE BOX VERZ	DISTANCE SLEEVE	CALE DE DISTANCE	2				
9	A51499401	BOXROHR 102 GESCHW R9005	BOX TUBE	BAC TUYAU	1				
10	A521038	KONTAKTWINKEL	BRACKET	EQUERRE-SUPPORT	1				
11	A52104101	VERSCHLUSSTOPFEN R9005	CAP	BOUCHON	1				
12	A52105601	AUFSATZ LINKS R9005	ADAPTER LEFT	ADAPTER GAUCHE	1				
13	A52105701	AUFSATZ RECHTS R9005	ADAPTER RIGHT	ADAPTER DROITE	1				
14	A521172	BOXGRIFF + ROHREINS.M8 KP	HANDLE	POINGEE	1				
15	A521269	FEDERKLAPPBOLZEN FKB 6X12	SPRING SNAP BOLT	BOULON BLOQUER	1				
16	A521459	CLIP FÜR GASDÄMPFERBEFESTIGUNG	CLIP	CLIP	2				
17	A521471	UNTERLAGSCHEIBE FÜR GRIFF	WASHER	RONDELLE	2				
18	A52157947	BOXDECKEL TR 2X BOHREN	BAG COVER	COUVRE-BAC VERT	1				
19	A700137	SCHEIBE A 6,4 125-ST VZ	WASHER	RONDELLE	15				
20	A700150	SCHEIBE 8,4 9021-ST VZ	WASHER	RONDELLE	2				
21	A700496	SCHRAUBE 6X 20 912- 8.8	SCREW	VIS	2				
22	A701124	MUTTER HUT 8 986- 8 VZ	NUT	ECROU	2				
23	A701704	SCHRAUBE 8X 60 933- 8.8VZ	SCREW	VIS	2				
24	A703005	SCHEIBE 6,4 9021-ST A3S	WASHER	RONDELLE	12				
25	A703363	SCHRAUBE 6X 35 933- 8.8A3S	SCREW	VIS	4				
26	A703563	SCHRAUBE 6X 45 933- 8.8A3C	SCREW	VIS	2				
27	A704325	SCHRAUBE 6X 40 933- 8.8A3S	SCREW	VIS	5				
28	A704536	MUTTER 6KT 6 985- 8 A3B	NUT	ECROU	13				
29	A704538	SCHEIBE A 8,4 125-ST A3B	WASHER	RONDELLE	2				



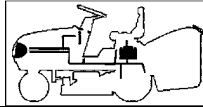

Crossover
102/15
 Art. 65058

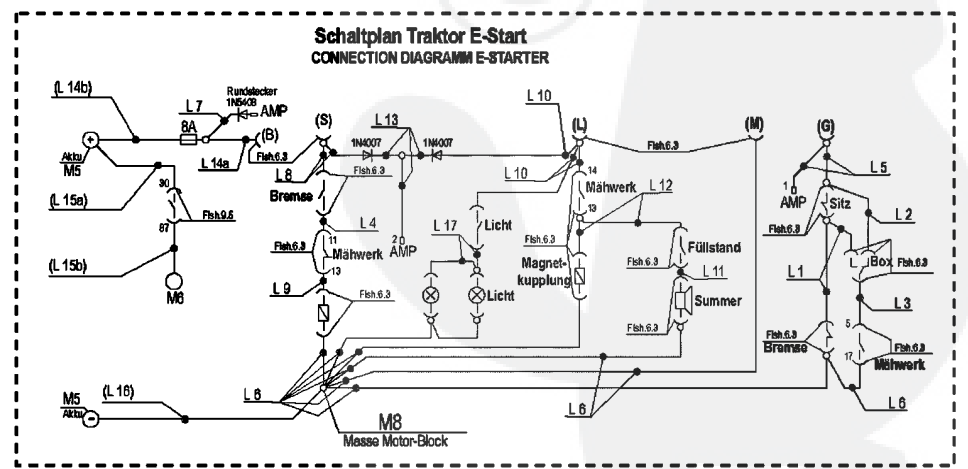
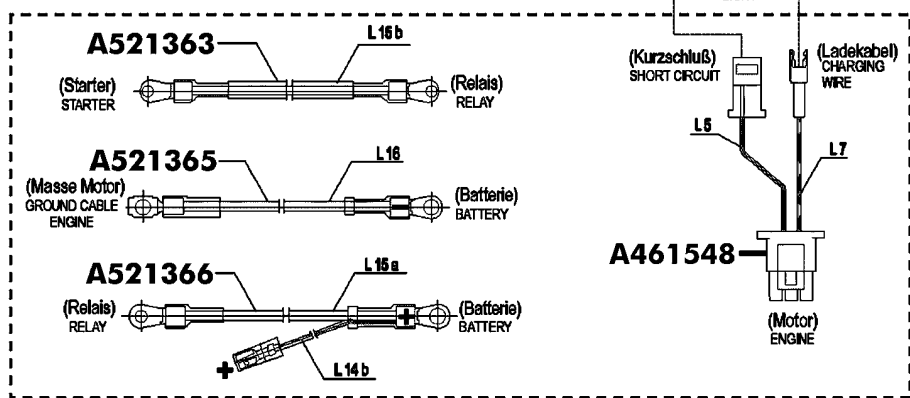
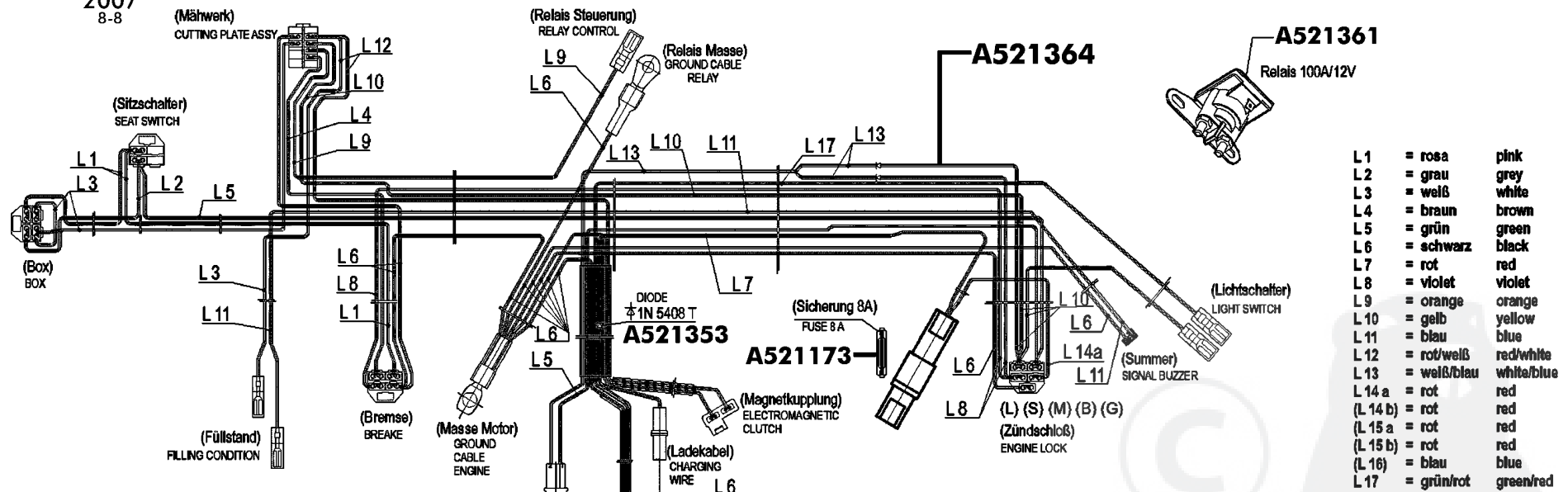
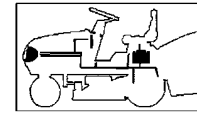
2007
 8-8

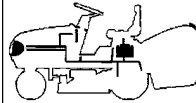

Technische Änderungen vorbehalten

22/22	RASENTRAKTOREN		ELEKTRIK 1 ELECTRIC 1 ELECTRIQUES 1	Crossover		 
2007	LAWN TRACTORS			102 / 15 - Art. 65058		
073802	Tracteurs de pelouse			Modell 2007		
Bild Nr. REF.N° POS.N°	BEST.-NR. PART-N° N° d. PIECE	BEZEICHNUNG	DESCRIPTION	DÉSIGNATION	Qty.	
1	A461548	ADAPTERKABEL F KABELBAUM B&S 14,5-20 HP	ADAPTER FOR B&S 14,5-20 HP	ADAPTER POUR B&S 14,5-20 HP	1	
2	A521173	SICHERUNG 8A	FUSE 8A	FUSIBLE 8A	1	
3	A521353	DIODE 5A IN5408 T ET	DIODE 5A	DIODE 5A	1	
4	A521361	STARTERRELAIS 12V/100AMPER	STARTER RELAY	RELAIS D'ALL.	1	
5	A521363	KABEL ROT STARTER/RELAIS	CABLE RED (RELAIS)	CABLE ROUGE (RELAIS)	1	
6	A521364	KABELBAUM E-START 102	CABLES ASSY. E-START 102	ENS. CABLAGES E-START 102	1	
7	A521365	KABEL BLAU MASSELEITER	CABLE BLUE (GROUNG CABLE)	CABLE BLEU	1	
8	A521366	KABEL ROT BATTERIE/RELAIS	CABLE RED BATTERY * RELAIS	CABLE ROUGE (BATTERIE-RALAIS)	1	

