

Stand 12.11.2001

ERSATZTEILLISTE

ECHO Motorsäge
CS-4000, CS-4010
CS-4500, CS-4510

ECHO-Motorgeräte
Vertrieb Deutschland GmbH
Otto-Schott-Str. 7

72555 Metzingen

Telefon 07123-1091
Telefax 07123-2589
<http://www.echo-shop.de>
email: info@echo-shop.de



CS-4000 1
CS-4500 1

Bild	Artikelnummer	Bezeichnung	Anzahl	Anmerkung
5	900281-05020	SCREW 5*20	9	
6	101005-19831	CYLINDER	1	CS-4000
6	101001-33731	CYLINDER	1	CS-4500
7	100011-19830	RING, PISTON	2	CS-4000
7	100011-33730	RING, PISTON	2	CS-4500
8	100003-19830	PISTON W/PIN	1	CS-4000
8	100000-19930	PISTON W/PIN	1	CS-4500
9	100015-00120	CIRCLIP, PISTON PIN	2	
12	130516-19830	BAND	1	
13	130510-19832	ADAPTER, INTAKE	1	
14	433016-11031	SCREW, TENSIONER	1	
15	433028-11030	CLIP	1	
16	433014-03932	TENSIONER	1	
17	433000-19831	CATCHER KIT, CHAIN	1	
18	+ 900281-05020	SCREW 5*20	1	
19	+ 900600-00005	WASHER 5	1	
24	100301-19832	CRANKCASE KIT	1	
22	+ 100212-19830	OILSEAL	1	

Bild	Artikelnummer	Bezeichnung	Anzahl	Anmerkung
25	+ 100215-02830	PIN, DOWEL	3	
26	+ 100121-19830	BEARING, BALL	1	
27	+ 433011-19830	STUD, GUIDE BAR	2	
34	+ 900301-20016	PIN, SPLIT 2*16	1	
50	+ 100253-19830	CUSHION (C)	1	
28	100100-19830	CRANKSHAFT ASSY	1	
10	+ 100020-19830	BEARING, NEEDLE (V)	1	
10	+ 100021-19830	BEARING, NEEDLE (B)	1	
10	+ 100022-19830	BEARING, NEEDLE (R)	1	
29	100142-12330	KEY, WOODRUFF	1	
31	900281-05030	SCREW 5*30	4	
35	436001-19832	CAP ASSY, OIL TANK	1	
36	+ 436012-19830	O-RING	1	
37	+ 131050-19830	RETAINER, LINK	1	
38	+ 900258-03008	SCREW 3*8	1	
39	+ 131051-19830	LINK	1	
45	101514-30130	COVER, CYLINDER	1	
46	101520-19830	COVER	1	
51	900345-50010	PIN, SPRING 5*10SUS	1	

CS-4000 2

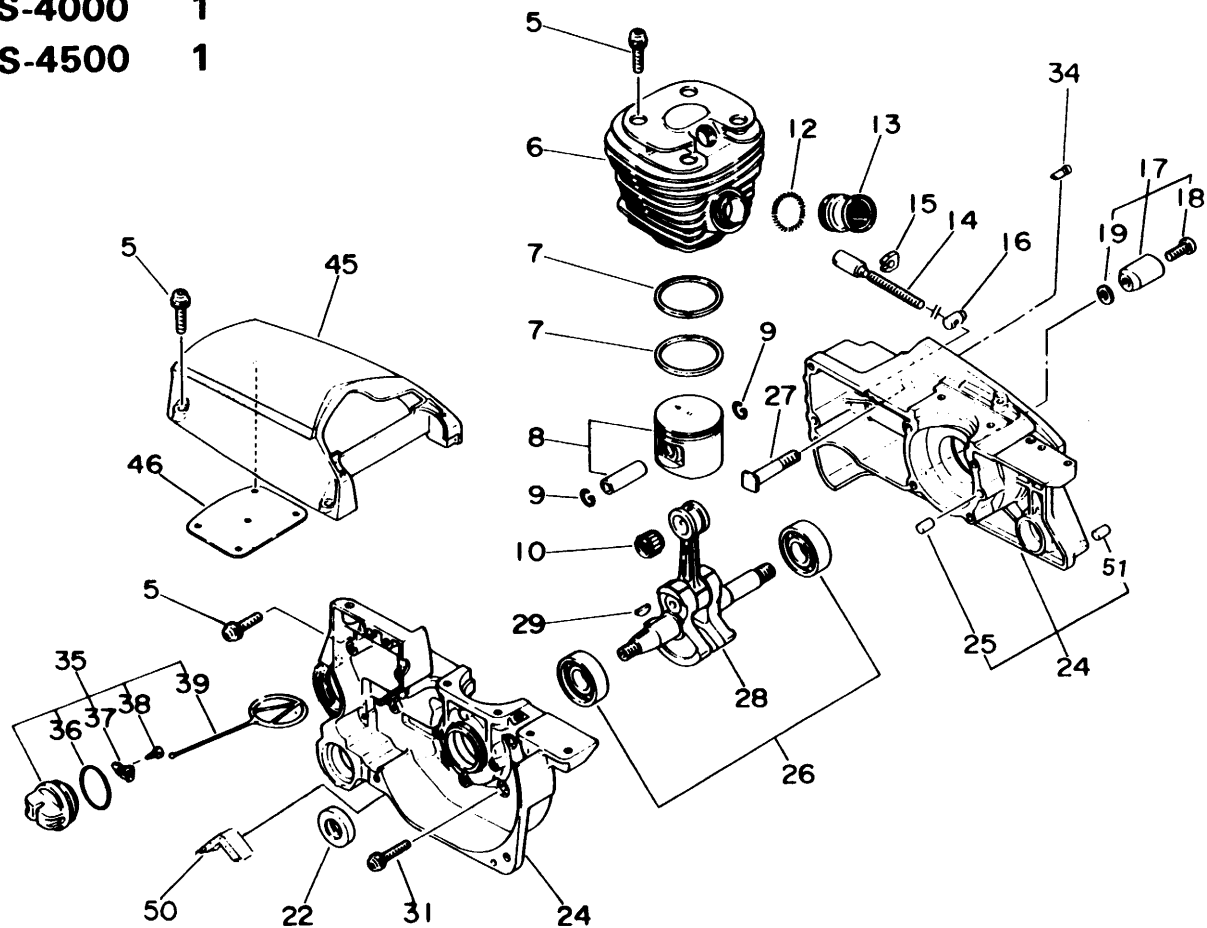

Bild	Artikelnummer	Bezeichnung	Anzahl	Anmerkung
29	178510-19830	ROD, CHOKE	1	CS-4000
5	890613-30130	LABEL, MODEL	1	CS-4000
6	130302-30130	COVER, AIR CLN W/SC	1	CS-4000
7 +	130406-19831	NUT, THUMB	1	CS-4000
8 +	900720-00003	O-RING 3	1	CS-4000
10	130303-19830	FILTER, AIR W/SEAL	1	CS-4000
11	130310-19830	FILTER, AIR	1	CS-4000
13	130356-19830	GROMMET	1	CS-4000
14	150110-03930	BUSHING	1	CS-4000
15	129013-19830	SCREW, IDLE ADJUST	1	CS-4000
16	129010-19830	GROMMET	1	CS-4000
17	890169-30130	DECAL	1	CS-4000
18	100905-19830	CUSHION	1	CS-4000
20	130110-19830	PIPE, IMPULSE	1	CS-4000
21	900281-05014	SCREW 5*14	1	CS-4000
22	900281-05055	SCREW 5*55	2	CS-4000
23	129011-19831	PLATE	1	CS-4000
24	130405-19831	BRACKET, AIR CLEAN	1	CS-4000
25	123000-19833	CARBURETOR ASSY	1	CS-4000
26	130007-19830	INSULATOR	1	CS-4000
27 +	130020-19830	NUT	2	CS-4000
28	178810-11231	GROMMET	1	CS-4000

Bild	Artikelnummer	Bezeichnung	Anzahl	Anmerkung
29	178510-19830	ROD, CHOKE	1	CS-4000
30	178307-19831	ROD, THROTTLE ASS	1	CS-4000
31	130012-19830	SEAL, DUST	1	CS-4000
32	178114-19830	HOLDER, THR. LEVER	1	CS-4000
33	163400-30830	SWITCH, IGNITION	1	CS-4000
34	890157-30130	LABEL, SWITCH	1	CS-4000
35	162022-30131	LEAD, GROUND	1	CS-4000
36	900281-05025	SCREW 5*25	4	CS-4000
37	130306-19831	CASE, CARBURETOR	1	CS-4000
38	163810-30130	BRACKET, SWITCH	1	CS-4000
39	130337-30130	PLUG, CARB. CASE	1	CS-4000
40	163911-30130	PLUG	1	CS-4000
41	100910-19830	CUSHION	1	CS-4000
43	900281-05010	SCREW 5*10	1	CS-4000
44	100918-19830	CAP, CUSHION	1	CS-4000
46	101529-19830	PLATE, GUIDE	1	CS-4000
48	101014-19830	STUD, MUFFLER	2	CS-4000
49	145510-19830	GASKET, MUFFLER	1	CS-4000
50	145610-30130	MUFFLER (C)	1	CS-4000
51	145711-19830	BRACKET, MUFFLER	1	CS-4000
52	433020-00830	LOCKNUT 5	2	CS-4000
54	145861-19830	LID, MUFFLER	1	CS-4000
55	900242-04008	SCREW	2	CS-4000
70	178078-19830	SPRING	1	CS-4000

CS-4500 2

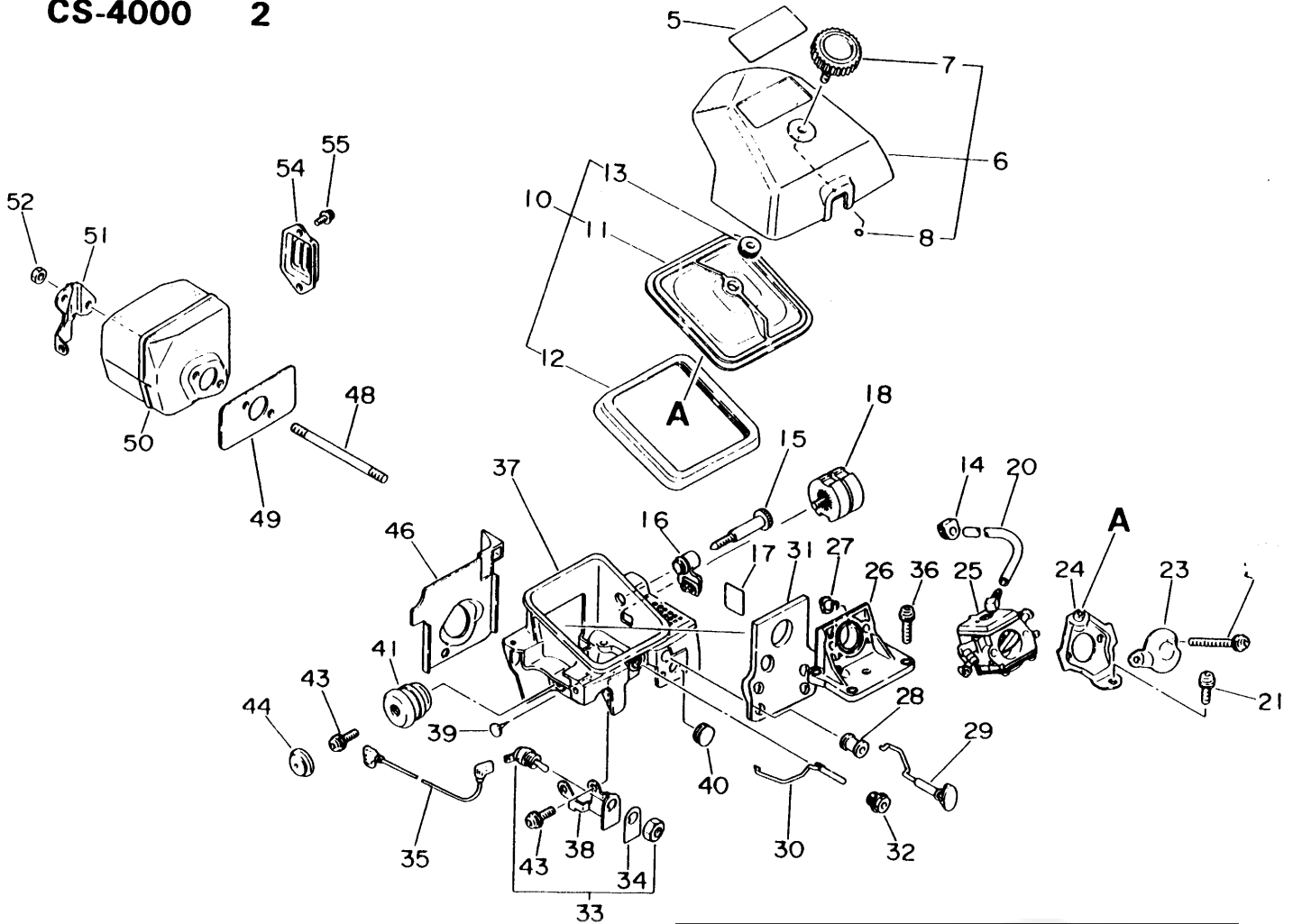

Bild	Artikelnummer	Bezeichnung	Anzahl	Anmerkung
5	890613-30230	LABEL, MODEL	1	CS-4500
6	130302-30130	COVER, AIR CLN W/SC	1	CS-4500
7 +	130406-19831	NUT, THUMB	1	CS-4500
8 +	900720-00003	O-RING 3	1	CS-4500
9	130351-30130	ADAPTER	1	CS-4500
11	130310-19830	FILTER, AIR	1	CS-4500
14	150110-03930	BUSHING	1	CS-4500
15	129013-19830	SCREW, IDLE ADJUST	1	CS-4500
16	129010-19830	GROMMET	1	CS-4500
17	890169-30130	DECAL	1	CS-4500
18	100905-19830	CUSHION	1	CS-4500
20	130110-19830	PIPE, IMPULSE	1	CS-4500
21	900281-05014	SCREW 5*14	1	CS-4500
22	900281-05055	SCREW 5*55	2	CS-4500
23	129011-19831	PLATE	1	CS-4500
24	130405-19831	BRACKET, AIR CLEAN	1	CS-4500
25	123000-19833	CARBURETOR ASSY	1	CS-4500
26	130007-19830	INSULATOR	1	CS-4500
27 +	130020-19830	NUT	2	CS-4500
28	178810-11231	GROMMET	1	CS-4500
29	178510-19830	ROD, CHOKE	1	CS-4500
30	178307-19831	ROD, THROTTLE ASS	1	CS-4500

Bild	Artikelnummer	Bezeichnung	Anzahl	Anmerkung
31	130012-19830	SEAL, DUST	1	CS-4500
32	178114-19830	HOLDER, THR. LEVER	1	CS-4500
33	163400-30830	SWITCH, IGNITION	1	CS-4500
34	890157-30130	LABEL, SWITCH	1	CS-4500
35	162022-30131	LEAD, GROUND	1	CS-4500
36	900281-05025	SCREW 5*25	4	CS-4500
37	130306-19831	CASE, CARBURETOR	1	CS-4500
38	163810-30130	BRACKET, SWITCH	1	CS-4500
39	130337-30130	PLUG, CARB. CASE	1	CS-4500
40	163911-30130	PLUG	1	CS-4500
41	100910-19830	CUSHION	1	CS-4500
43	900281-05010	SCREW 5*10	1	CS-4500
44	100918-19830	CAP, CUSHION	1	CS-4500
46	101529-19830	PLATE, GUIDE	1	CS-4500
48	101014-19830	STUD, MUFFLER	2	CS-4500
49	145510-19830	GASKET, MUFFLER	1	CS-4500
50	145610-30130	MUFFLER (C)	1	CS-4500
51	145711-19830	BRACKET, MUFFLER	1	CS-4500
52	433020-00830	LOCKNUT 5	2	CS-4500
54	145861-19830	LID, MUFFLER	1	CS-4500
55	900242-04008	SCREW	2	CS-4500
70	178078-19830	SPRING	1	CS-4500

CS-4000 3
CS-4500 3

Bild	Artikelnummer	Bezeichnung	Anzahl	Anmerkung
5	156802-30130	FLYWHEEL W/W.KEY	1	
	+ 100142-30830	KEY, WOODRUFF	1	
6	101521-19830	FAN, COOLING	1	
7	100143-19830	WASHER	1	
8	900500-00008	NUT 8	1	
9	177234-19830	SPRING, RETURN	2	
10	177247-19830	SPACER, RATCHET	2	
11	177218-14530	PAWL, STARTER	2	
12	900603-00005	WASHER 5	2	
13	900281-05020	SCREW 5*20	4	
18	900281-04020	SCREW 4*20	4	
21	150112-00310	BUSHING	2	
22	156611-19830	TUBE	1	
23	159012-03433	CAP, SPARK PLUG	1	
24	159011-03432	COIL, SPARK PLUG C	1	
25	159017-16431	PLUG, SPARK (CJ-6Y)	1	
26	156618-30130	NUT	1	

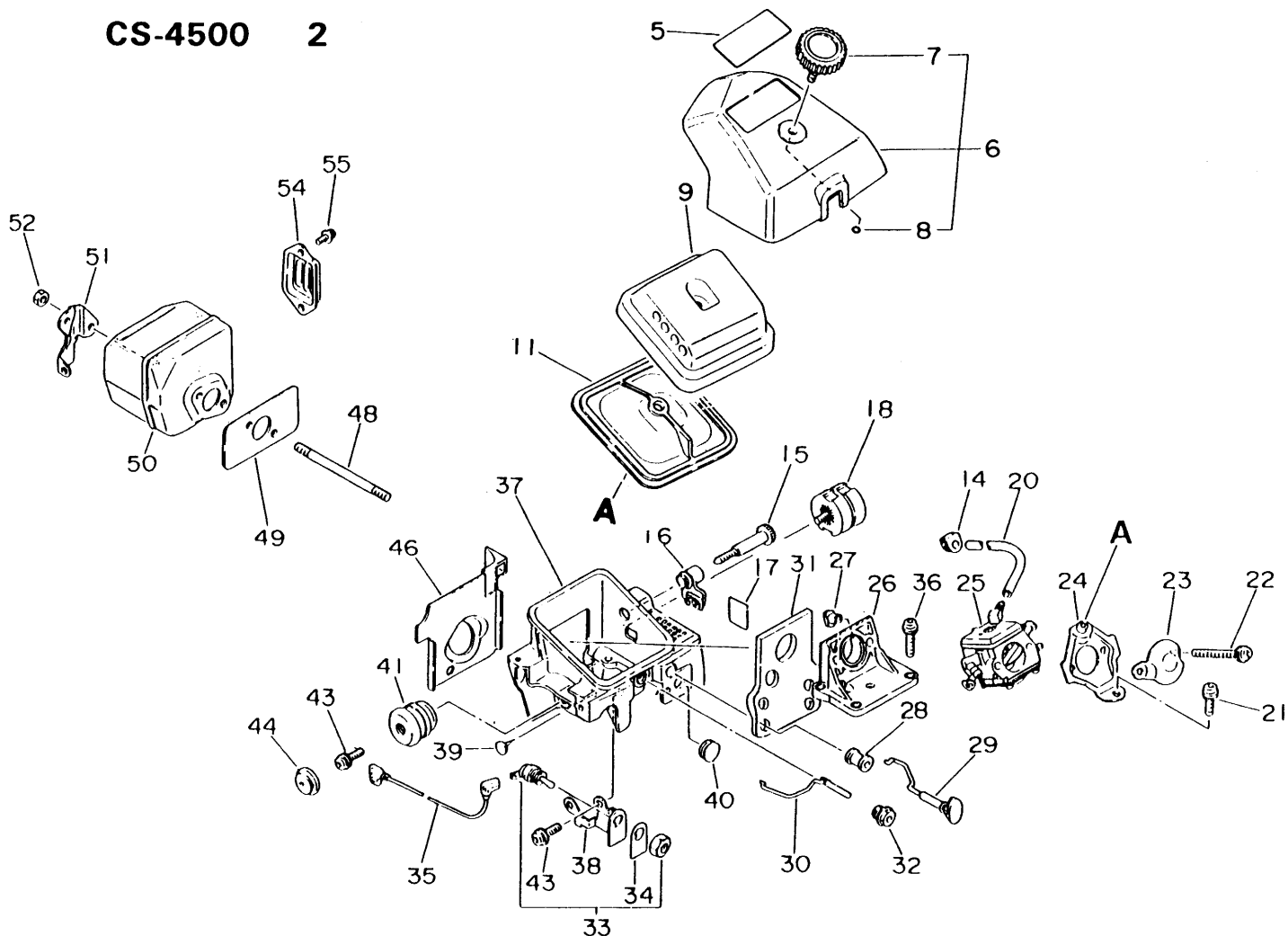
Bild	Artikelnummer	Bezeichnung	Anzahl	Anmerkung
27	156626-30130	COIL, IGNITION	1	
28	156630-30130	LEAD	1	
29	156601-30131	C.D.I. MODULE	1	
30	156114-04920	GROMMET	1	
31	101535-19830	COVER, FAN (INNER)	1	
33	900281-05014	SCREW 5*14	2	
32	177200-19830	STARTER ASS'Y	1	
33	+ 900281-05014	SCREW 5*14	1	
34	+ 177214-02830	WASHER	1	
35	+ 177215-14531	DRUM, STARTER	1	
36	+ 177226-19830	ROPE, STARTER	1	
37	+ 177242-03930	PLATE, STARTER	1	
38	+ 177220-03930	SPRING, REWIND	1	
39	+ 177221-03930	PLATE, STARTER	1	
41	+ 177228-19830	GRIP, STARTER	1	
42	+ 177227-05020	GUIDE, ROPE	1	
43	+ 101507-19830	COVER, FAN	1	
44	890112-17831	LABEL, ECHO	1	

CS-4000 4

CS-4500 4

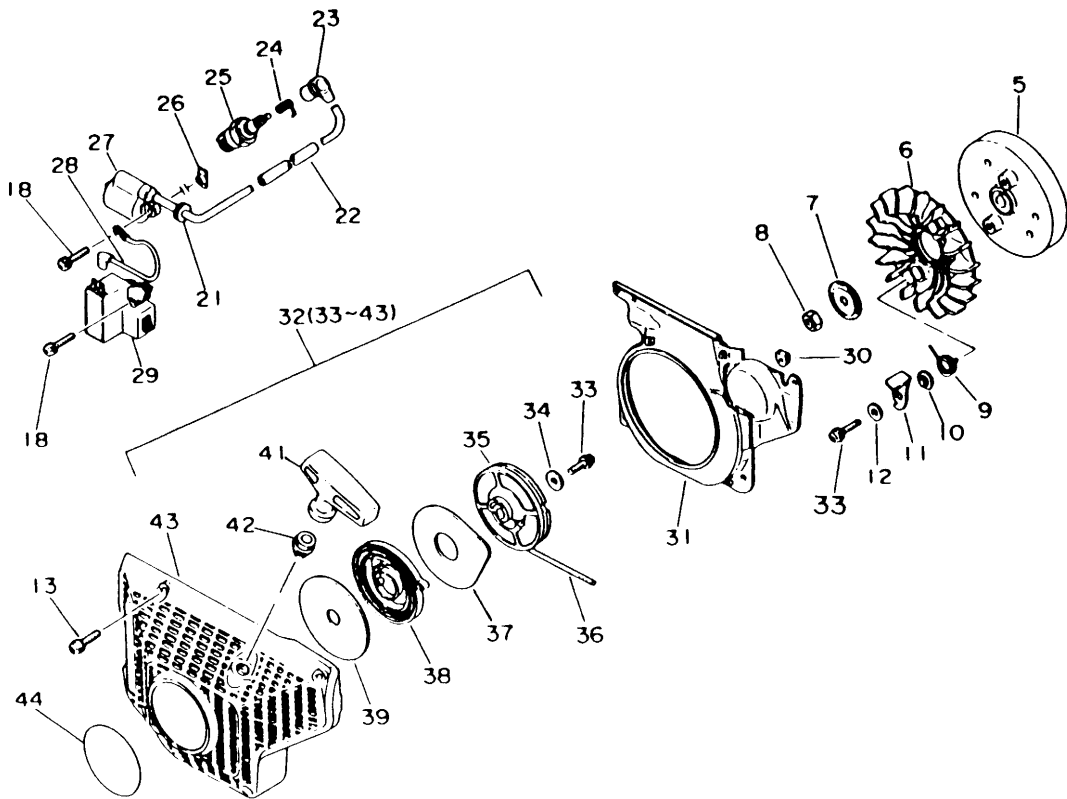

Bild	Artikelnummer	Bezeichnung	Anzahl	Anmerkung
1	100127-19830	WASHER, ADJUSTING	1	
4	437000-32330	AUTO-OILER ASSY	1	
5	+ 437063-30130	WORM (S)	1	
15	+ 900720-00003	O-RING 3	1	
6	100212-32430	OILSEAL (L)	1	
9	132115-12330	GROMMET	1	
10	437210-19930	PIPE, OIL	1	
11	436205-14730	STRAINER, OIL	1	

Bild	Artikelnummer	Bezeichnung	Anzahl	Anmerkung
12	437039-19831	KNOB	1	
13	437015-19830	SPRING	1	
14	900700-00003	E-RING 3	1	
15	900720-00003	O-RING 3	1	
17	437605-32430	COVER, OIL PUMP	1	
19	900281-04014	SCREW 4*14	3	
35	890155-30130	LABEL, CAUTION	1	
36	100610-30130	PLUG	1	

CS-4000 5
CS-4500 5

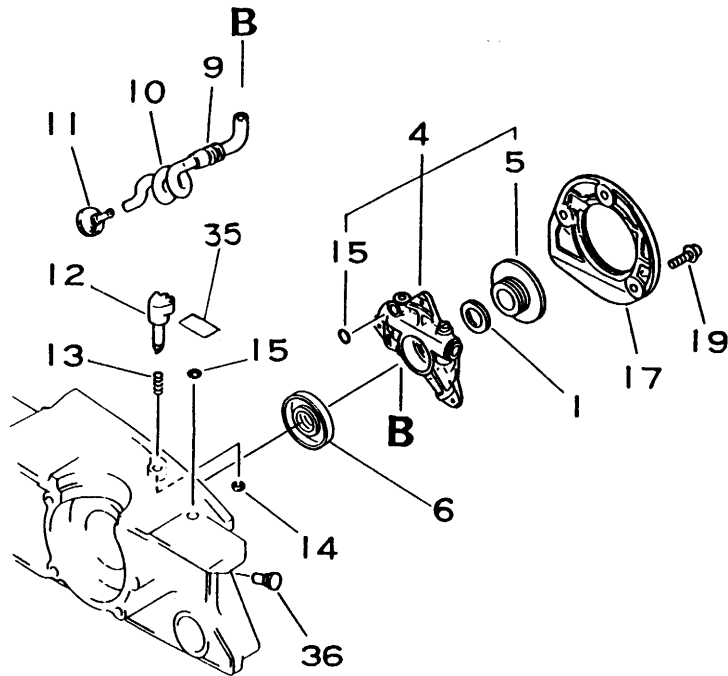

Bild	Artikelnummer	Bezeichnung	Anzahl	Anmerkung
5	132115-01460	GROMMET	2	
6	132012-19830	PIPE 3*6*100	1	
7	132011-19830	CONNECTOR, FUEL P	1	
8	132010-19830	PIPE	1	
9	131205-19830	STRAINER, FUEL	1	
12	100910-19831	CUSHION	3	
13	100917-19830	CUSHION	1	
14	900281-05010	SCREW 5*10	3	
15	100918-19830	CAP, CUSHION	3	
17	900281-05020	SCREW 5*20	4	
18	900281-04014	SCREW 4*14	1	
19	351155-30130	COVER, HANDLE	1	
20	178090-30130	LOCKOUT, T. CONTRO	1	
21	178073-19831	CUSHION, THROTTLE	1	
22	178043-19830	SPRING, THR. RETUR	1	
23	178010-19830	CONTROL, THROTTLE	1	
24	900340-50025	PIN, SPRING 5*25	1	
25	351111-19830	GRIP, HANDLE	1	
30	131314-06320	VALVE, CHECK	1	
31	131315-05020	FILTER	1	
32	351103-19830	HANDLE, W/FUEL TAN	1	
26 +	100251-19830	CUSHION (A)	1	

Bild	Artikelnummer	Bezeichnung	Anzahl	Anmerkung
27 +	100252-19830	CUSHION (B)	1	
34	178302-30130	LATCH, THROTTLE	1	
35	131004-19830	CAP ASSY, FUEL TAN	1	
36 +	900720-00029	O-RING 29	1	
37 +	131050-19830	RETAINER, LINK	1	
38 +	900258-03008	SCREW 3*8	1	
39 +	131051-19830	LINK	1	
40	900281-05014	SCREW 5*14	2	
42	351614-30130	BRACKET, F. HANDLE	1	
43	351606-30130	HANDLE, FRONT	1	
44	351613-30130	SUPPORTER, F. HAND	1	
60	433201-30130	LEVER ASSY, BRAKE	1	
61 +	433113-30130	SCREW	1	
62 +	900330-40080	PIN F 4*8	1	
63 +	433119-30130	STOPPER (D)	1	
64 +	433137-30130	NUT	1	
65 +	900330-30240	PIN 3*24	1	
66 +	900330-30180	PIN 3*18	1	
67 +	433168-19930	SPACER (B)	1	
69 +	900340-30012	PIN, SPRING 3*12	2	
70 +	433170-30130	TRIGGER, BRAKE	1	
71 +	433114-30130	SPRING, RETURN	1	
72 +	900345-30014	PIN, SPRING 3*14	1	

CS-4000 6

CS-4500 6

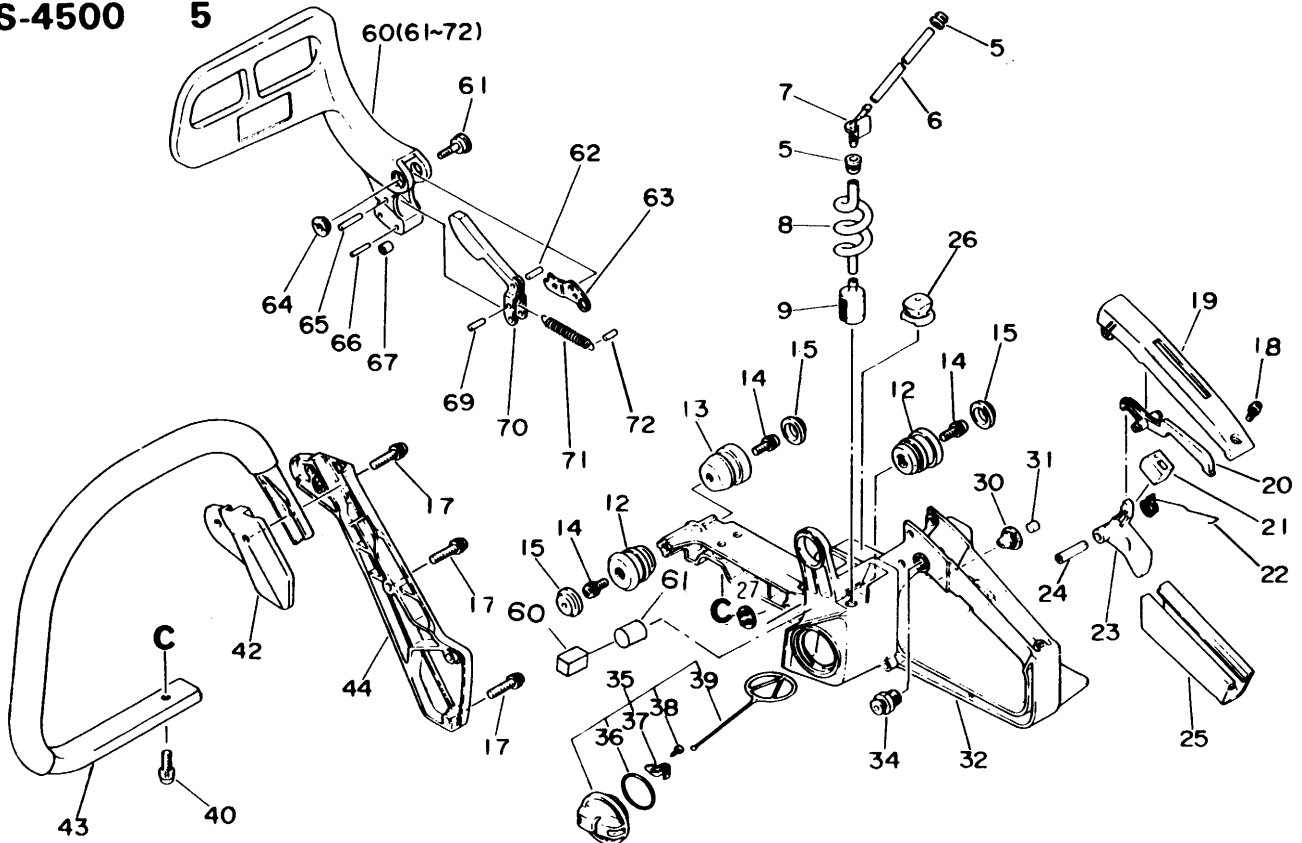

Bild	Artikelnummer	Bezeichnung	Anzahl	Anmerkung
5	890118-18331	LABEL, ECHO	1	
6	433019-12330	NUT, FLANGE 8	1	
7	433002-19930	GUARD, SPROCKET (A	1	
4	+ 433025-19930	PAD	1	
8	433312-19930	COVER, SEAL	1	
9	433012-14533	PLATE, GUIDE (OUTER	1	
10	900241-03006	SCREW 3*6	1	
11	900281-04010	SCREW 4*10	1	
12	433013-19831	PLATE, GUIDE (INNER	1	
14	430513-30130	BAR, GUIDE 33RV-325	1	
14	430521-30130	BAR, GUIDE 38RV-325	1	
15	431713-16630	CHAIN, SAW 21AP-56	1	
15	431721-30130	CHAIN 21AP-64E	1	
18	175000-19830	CLUTCH ASSY	1	
19	+ 175019-19830	PLATE, CLUTCH	3	
20	+ 175016-19830	HUB, CLUTCH	1	
21	+ 175018-19830	SPRING, CLUTCH	1	
22	+ 175002-19830	SHOE, CLUTCH	1	
23	+ 900281-04008	SCREW 4*8	6	
24	175012-19830	BEARING, NEEDLE	1	
25	175105-19831	DRUM, CLUTCH	1	

Bild	Artikelnummer	Bezeichnung	Anzahl	Anmerkung
26	175114-12530	SPROCKET, RIM .325	1	
	433202-19931	BRAKE KIT, CHAIN	1	
30	+ 433306-19930	COVER, BRAKE	1	
31	+ 433133-19930	BOLT	1	
32	+ 900502-00005	NUT 5 (3N)	1	
33	+ 433162-19930	WASHER	1	
34	+ 433122-19930	SPRING, BRAKE	1	
35	+ 433209-19930	STOPPER	1	
36	+ 433208-19930	LEVER, BRAKE	1	
37	+ 900340-40010	PIN, SPRING 4*10	2	
38	+ 433310-19931	COVER, BRAKE	1	
39	+ 900281-04010	SCREW 4*10	2	
40	+ 433169-19931	NUT, ADJUSTING	1	
41	+ 433161-19930	SPRING	1	
42	+ 433142-19931	ADJUSTER, BRAKE	1	
43	+ 433123-19930	BAND, BRAKE	1	
48	880210-30131	BUMPER, SPIKED	1	
49	880211-30130	BOLT	2	
51	895410-02830	WRENCH, W/S. DRIVE	1	
52	895812-03930	DRIVER, SCREW 50	1	
53	898513-14530	SCABBARD, GUIDE BA	1	

CS-4000 7
CS-4500 7

Bild	Artikelnummer	Bezeichnung	Anzahl	Anmerkung
	123000-19833	CARBURETOR ASSY	1	
1	+ 123110-03930	SCREW, PUMP COVER	1	
2	+ 123124-19830	COVER, FUEL PUMP	1	
3	+ 123125-12330	GASKET, FUEL PUMP	1	
4	+ 123112-12330	DIAPHRAGM, FUEL PU	1	
5	+ 123114-03930	SCREW	3	
6	+ 123132-17330	VALVE, CHOKE	1	
7	+ 123136-10630	BALL, CHOKE FRICTIO	1	
8	+ 123135-10630	SPRING, CHOKE FRIC	1	
9	+ 123126-10631	SCREEN, INLET	1	
11	+ 123113-16130	SPRING, THRT. RETU	1	
12	+ 123117-19830	SHAFT, THROTTLE	1	
13	+ 123116-10530	VALVE, THROTTLE	1	
14	+ 123131-19830	SHAFT, CHOKE	1	
15	+ 123156-12330	STOP, THROTTLE	1	
16	+ 123133-11130	SPRING, IDLE ADJUST	1	
18	+ 123118-18331	NEEDLE, IDLE	1	

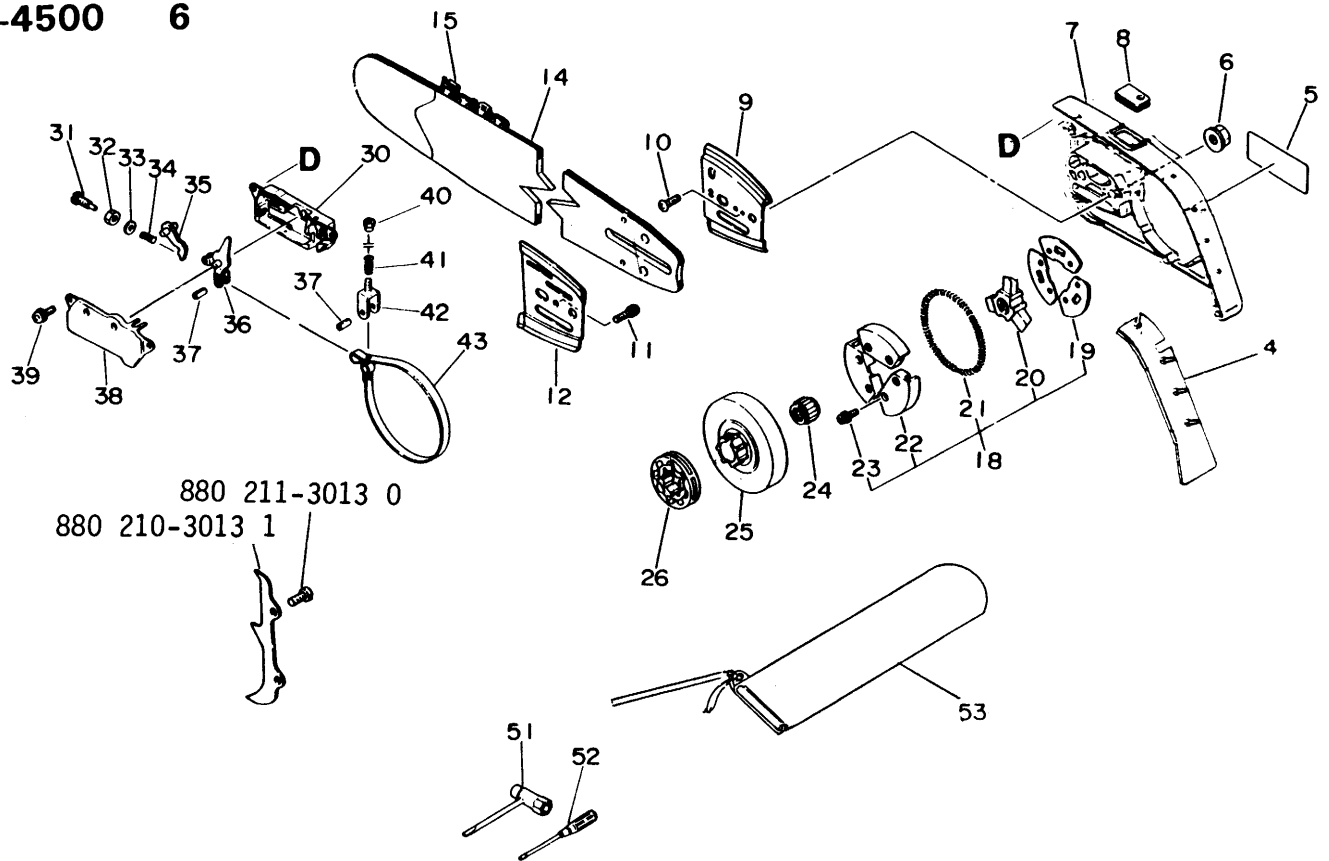
Bild	Artikelnummer	Bezeichnung	Anzahl	Anmerkung
19	+ 123121-03930	SPRING, NEEDLE	2	
20	+ 123120-18431	NEEDLE, HIGH SPEED	1	
21	+ 123123-18330	LEVER, METERING	1	
22	+ 123122-11130	SPRING, METER. LEV	1	
23	+ 123137-16130	VALVE, INLET NEEDLE	1	
24	+ 123138-03930	PIN, METERING LEVE	1	
25	+ 123139-03930	SCREW, M. LEVER PIN	1	
27	+ 123140-16131	GASKET, M. DIAPHRA	1	
28	+ 123141-16131	DIAPHRAGM, METER	1	
29	+ 123142-17330	COVER, M. DIAPHRA	1	
30	+ 123130-02960	SCREW	4	
31	+ 123168-10631	SCREEN	1	
32	+ 123169-10630	RING, RETAINING	1	
33	+ 123146-17330	PLUG, CUP	1	
34	+ 123178-15030	PLUG, FRICTION	1	
35	+ 123146-10630	PLUG, WELCH	1	

CS-4010 3
CS-4510

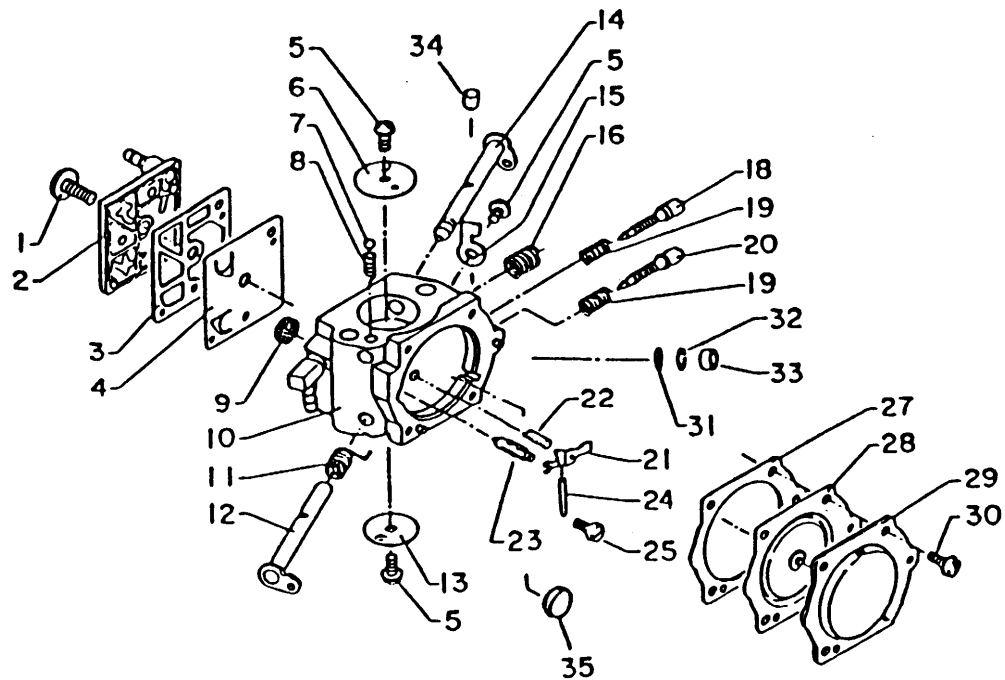

Bild	Artikelnummer	Bezeichnung	Anzahl	Anmerkung
3	156638-32130	COIL, STATOR	1	CS-4010,CS-4510
4	900281-04016	SCREW 4*16	2	CS-4010,CS-4510
5	156800-32130	FLYWHEEL	1	CS-4010,CS-4510
6	101521-19830	FAN, COOLING	1	CS-4010,CS-4510
7	100143-19830	WASHER	1	CS-4010,CS-4510
8	900500-00008	NUT 8	1	CS-4010,CS-4510
9	177234-19830	SPRING, RETURN	2	CS-4010,CS-4510
10	177247-19830	SPACER, RATCHET	2	CS-4010,CS-4510
11	177218-14530	PAWL, STARTER	2	CS-4010,CS-4510
12	900603-00005	WASHER 5	2	CS-4010,CS-4510
13	900281-05014	SCREW 5*14	2	CS-4010,CS-4510
18	900281-04020	SCREW 4*20	4	CS-4010,CS-4510
21	150112-00310	BUSHING	2	CS-4010,CS-4510
22	156611-19830	TUBE	1	CS-4010,CS-4510
23	159012-03433	CAP, SPARK PLUG	1	CS-4010,CS-4510
24	159011-03432	COIL, SPARK PLUG C	1	CS-4010,CS-4510
25	159017-16431	PLUG, SPARK (CJ-6Y)	1	CS-4010,CS-4510
26	156618-30130	NUT	1	CS-4010,CS-4510
27	156626-30130	COIL, IGNITION	1	CS-4010,CS-4510
28	156630-30130	LEAD	1	CS-4010,CS-4510
29	156601-30131	C.D.I. MODULE	1	CS-4010,CS-4510

CS-4010 5
CS-4510

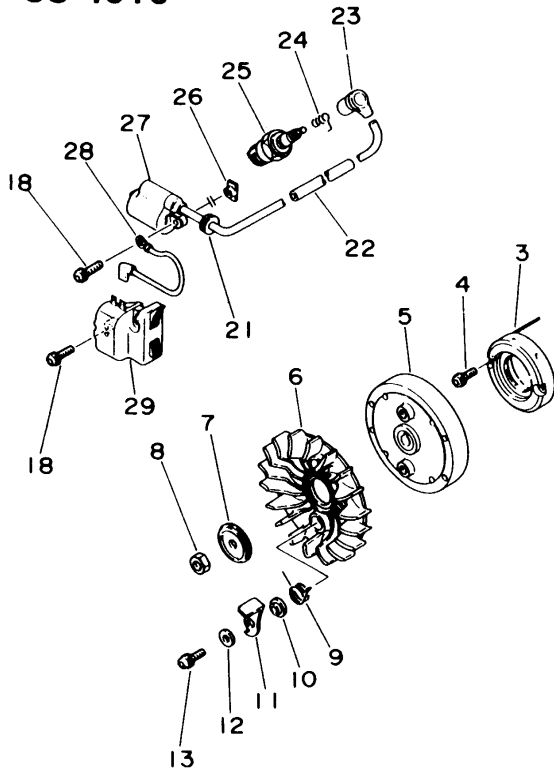

Bild	Artikelnummer	Bezeichnung	Anzahl	Anmerkung
17	900281-05020	SCREW 5*20	5	CS-4010,CS-4510
18	900281-04014	SCREW 4*14	1	CS-4010,CS-4510
19	351155-32130	COVER, HANDLE	1	CS-4010,CS-4510
20	178090-19830	LOCKOUT, T. CONTRO	1	CS-4010,CS-4510
21	178073-19831	CUSHION, THROTTLE	1	CS-4010,CS-4510
22	178043-32130	SPRING, THR, RETUR	1	CS-4010,CS-4510
23	178010-19830	CONTROL, THROTTLE	1	CS-4010,CS-4510
24	900345-50025	PIN, SPRING 5*25SUS	1	CS-4010,CS-4510
25	351102-32130	GRIP ASSY, F-HANDL	1	CS-4010,CS-4510
32	351103-32130	HANDLE, REAR	1	CS-4010,CS-4510
40	900281-05014	SCREW 5*14	2	CS-4010,CS-4510
42	351614-30130	BRACKET, F. HANDLE	1	CS-4010,CS-4510
43	351606-32130	HANDLE, FRONT	1	CS-4010,CS-4510
44	351613-30130	SUPPORTER, F. HAND	1	CS-4010,CS-4510
55	163400-32130	SWITCH, IGNITION	1	CS-4010,CS-4510
56	162022-32130	LEAD, GROUND	1	CS-4010,CS-4510
57	178091-32130	SPRING, THR, LOCKO	1	CS-4010,CS-4510
58	163400-19831	SWITCH, IGNITION	1	CS-4010,CS-4510
59	890157-32130	LABEL, SWITCH	1	CS-4010,CS-4510
60	159118-32130	GUIDE, CORD	1	CS-4010,CS-4510
61	159112-32130	CLIP	1	CS-4010,CS-4510
62	900281-04008	SCREW 4*8	1	CS-4010,CS-4510

ECHO®

Motorgeräte

die geh'n ran

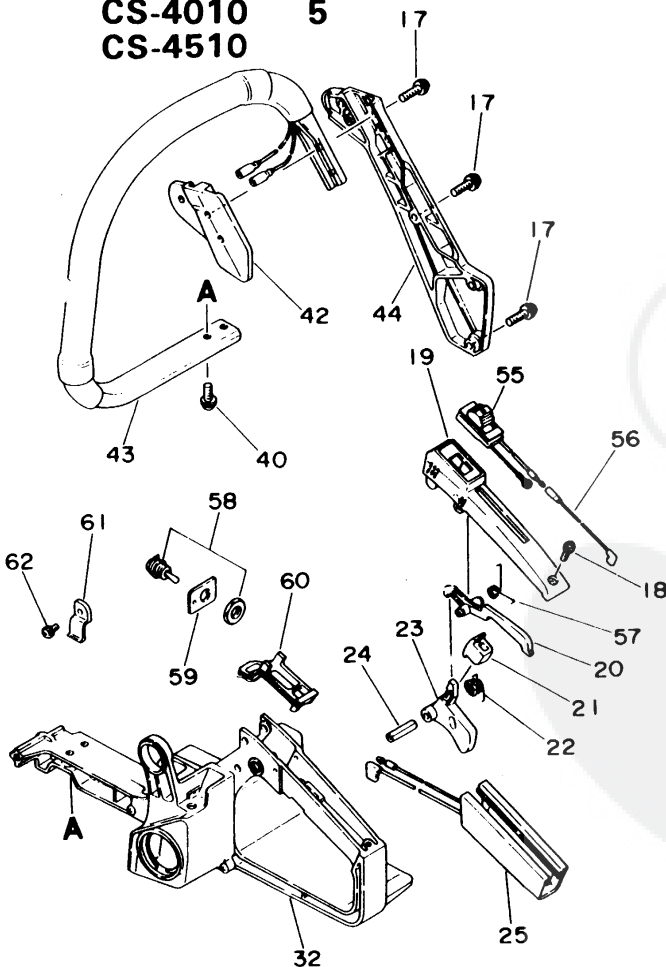