



ISSUED NO. HR531-OH-0

Parts catalogue

BULL MOWER

(EXPORT MODEL)

HR531-OH

MODEL	CODE
HR531	0256-0000

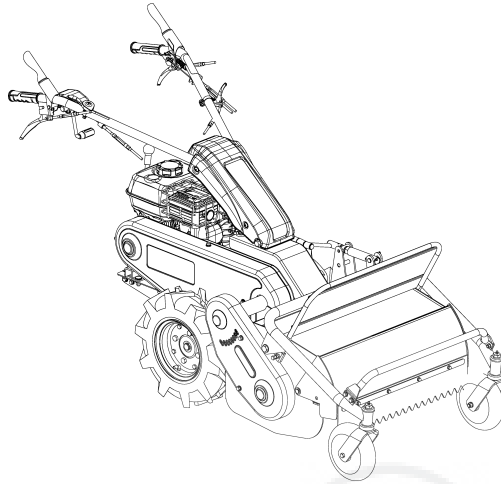

CONTENTS

Fig. 1	HANDLE	-----	1
Fig. 2	FRAME	-----	3
Fig. 3	TRANSMISSION	-----	8
Fig. 4	ROTARY COVER	-----	14
Fig. 5	ENGINE	-----	19
Fig. 6	LABEL	-----	21

**OREC**

Update : Sep,2020

Handle 1/2

Ref.	Parts No.	Parts Name	Qty	Remark
1	80-1417-253-00	Stopper	1	
2	0211-20400	Blade Tension Lever	1	
3	0211-20501	Upper Cover (White)	1	
4	0211-70410	Stopper Return Spring	1	
5	0285-78200	Handle Bonnet	1	
6	0301-71200	Throttle Wire (GX270.340)	1	
7	0301-77100	Throttle Lever	1	
8	0334-75200	Lever Grip (Red) 10	1	
9	83-1110-965-20	Tension Wire	1	
10	83-1415-453-10	Lever 27-05-0822S	1	
11	83-1614-932-10	Tension Wire	1	
12	89-1137-060122	Hexagonal Bolt (PW) M6*12	1	
13	89-1159-060108	Truss Mini Screw M6*10	4	
14	89-2521-000050	E Type Ring 5	2	
15	89-2521-000100	E Type Ring 10	1	

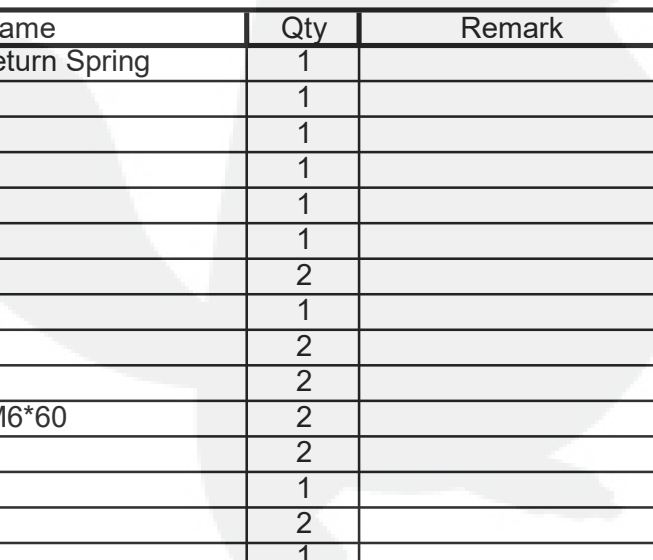
Handle 2/2

Ref.	Parts No.	Parts Name	Qty	Remark
1	80-1417-971-10	Blade Clutch Lever Return Spring	1	
2	0211-20101	Handle CMP (White)	1	
3	0211-20200	Driving Clutch Lever	1	
4	0211-20300	Blade Clutch Lever	1	
5	0211-20600	Brake Spring	1	
6	0211-70510	Brake Wire	1	
7	0334-75300	Handle Grip 27	2	
8	83-1614-932-10	Tension Wire	1	
9	83-1614-962-10	Side Clutch Wire	2	
10	83-1761-457-00	Side Clutch Lever	2	
11	89-1113-060602	Hexagonal Bolt (8T) M6*60	2	
12	89-1551-060002	Hexagonal U Nut M6	2	
13	89-2120-200152	Split Pin 2*15	1	
14	89-2131-060002	Snap Pin 6	2	
15	89-2521-000050	E Type Ring 5	1	

Ref.	Parts No.	Parts Name	Qty	Remark
1	80-1210-222-00	Handle Setting Collar	1	
2	80-1310-228-00	Handle Fix Nut	2	
3	80-1565-413-11	Wheel Boss (White)	2	
4	80-1711-411-00	Tire Assy (Left) 400-7	1	
5	80-1711-412-00	Tire Assy (Right) 400-7	1	
6	83-1210-133-00	Setting Bolt M12*160	1	
7	89-1111-100202	Hexagonal Bolt M10*20	8	
8	89-1511-100042	Hexagonal Nut M10	8	
9	89-1750-100002	Spring Washer 10	8	
10	89-1750-120002	Spring Washer 12	2	
11	89-2150-070500	Key 7*50 (round)	2	
12	89-2511-000220	Snap Ring (S22)	2	
13	-	Handle Part	1	Page 1 ~

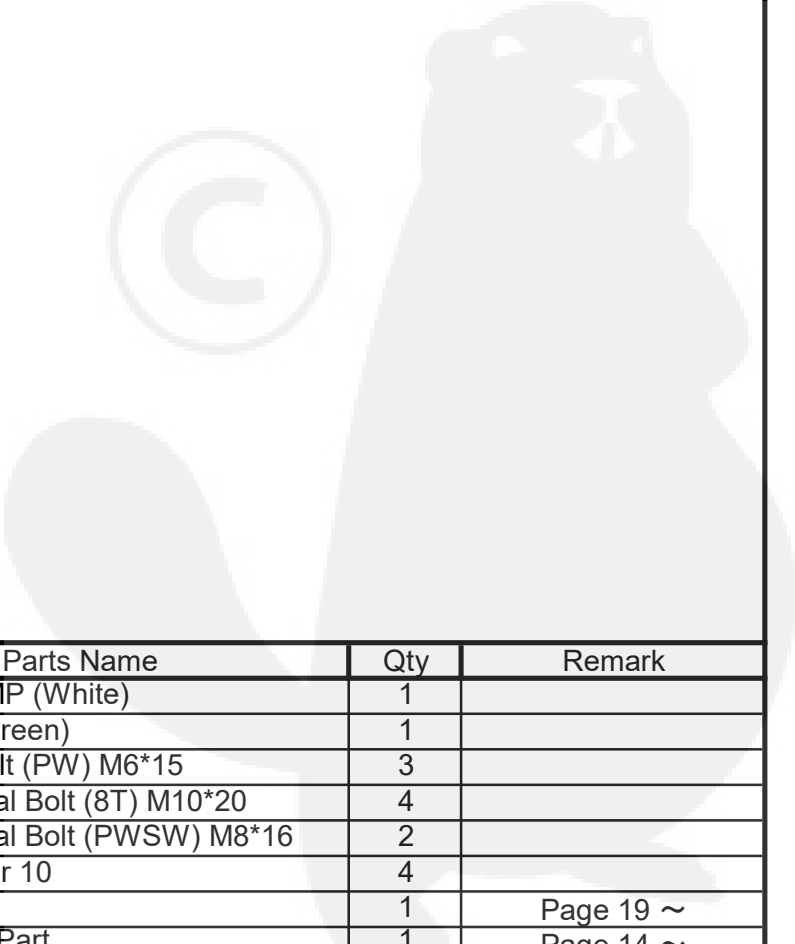

Ref.	Parts No.	Parts Name	Qty	Remark
1	80-1614-504-21	Belt Cover CMP (White)	1	
2	80-1614-746-1G	Side Cover (Green)	1	
3	89-1137-060152	Hexagonal Bolt (PW) M6*15	3	
4	89-1213-100202	Mini Hexagonal Bolt (8T) M10*20	4	
5	89-1233-080162	Mini Hexagonal Bolt (PWSW) M8*16	2	
6	89-1750-100002	Spring Washer 10	4	
7	-	Engine Part	1	Page 19 ~
8	-	Rotary Cover Part	1	Page 14 ~

Ref.	Parts No.	Parts Name	Qty	Remark
1	80-1560-551-00	Return Spring	2	
2	80-1614-374-30	Brake Rod	1	
3	80-1614-521-01	Transmission Pulley (White)	1	
4	80-1614-552-00	Tension Spring	2	
5	0211-54201	Driving Tension Arm CMP (White)	1	
6	0225-40601	Belt Holder CMP (White)	1	
7	0256-40401	Blade Tension Arm CMP (White)	1	
8	0256-51101	Belt Cover Inside CMP (White)	1	
9	83-1032-765-00	Tension Pulley	2	
10	89-1233-080162	Mini Hexagonal Bolt (PWSW) M8*16	4	
11	89-1543-100002	Mini Hexagonal Nut (SW) M10	1	
12	89-1713-100002	Flat Washer 10 (Large)	1	
13	89-2150-050200	Key 5*20 (round)	1	
14	89-2511-000170	Snap Ring (S17)	2	
15	89-2512-000400	Snap Ring (R40)	2	
16	89-2521-000150	E Type Ring 15	2	
17	89-3115-062034	Bearing 6203 2RS	2	



Ref.	Parts No.	Parts Name	Qty	Remark
1	80-1210-216-00	Stopper Pin	1	
2	80-1210-217-00	Stopper Spring	1	
3	80-1310-215-00	Stopper Cap	1	
4	0207-70800	Grommet 45-3.5	1	
5	0251-1100G	Stopper for Handle Up/Down (Green)	1	
6	0251-1130G	Change Plate (Green)	1	
7	0253-11501	Change Guide (White)	1	
8	0256-1020G	Under Bonnet CMP (Green)	1	
9	83-1565-329-02	Washer 13*22*2.3	1	
10	89-1211-100202	Mini Hexagonal Bolt M10*20	2	
11	89-1213-101302	Mini Hexagonal Bolt (8T) M10*130	1	
12	89-1253-080162	Flange Mini Hexagonal Bolt (8T) M8*16	2	
13	89-1543-080002	Mini Hexagonal Nut (SW) M8	1	
14	89-1750-080002	Spring Washer 8	2	
15	89-1750-100002	Spring Washer 10	2	
16	89-2131-120002	Snap Pin 12	1	

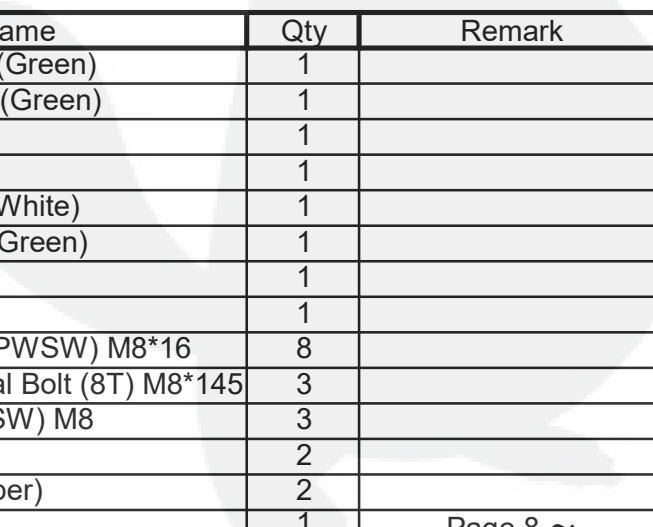

Ref.	Parts No.	Parts Name	Qty	Remark
1	80-1614-301-2G	Main Frame (L) CMP (Green)	1	
2	80-1614-302-2G	Main Frame (R) CMP (Green)	1	
3	80-1614-315-00	Return Spring	1	
4	0253-16100	Change Lever CMP	1	
5	0253-22411	Change Guide CMP (White)	1	
6	0253-2250G	Change Rod Setting (Green)	1	
7	0253-79100	Lever Grip 12.7	1	
8	0256-20510	Rear Bracket	1	
9	89-1233-080162	Mini Hexagonal Bolt (PWSW) M8*16	8	
10	89-1253-081453	Flange Mini Hexagonal Bolt (8T) M8*145	3	
11	89-1543-080002	Mini Hexagonal Nut (SW) M8	3	
12	89-1711-060002	Flat Washer 6	2	
13	89-2132-060002	Snap Pin 6 (with stopper)	2	
14	-	Transmission Part	1	Page 8 ~

Transmission 1/6

Ref.	Parts No.	Parts Name	Qty	Remark
1	80-1565-153-0H	Side Clutch Arm (Metallic Grey)	2	
2	80-1614-312-01	Brake Cover CMP (White)	1	
3	80-1614-314-00	Brake Cover	1	
4	0211-31800	Brake Packing (Large)	1	
5	0251-04301	Change Arm CMP (White)	1	
6	0256-71200	Label, Transmission	1	
7	83-1565-111-00	Hexagonal Bolt (with Big Washer) M6*16	1	
8	85-1445-317-00	Brake Packing (Small)	1	
9	85-1711-315-00	Brake Drum	1	
10	85-1711-317-00	Shoe Return Spring	2	
11	85-1711-318-00	Brake Shoe Set	1	
12	89-1132-060122	Hexagonal Bolt (SW) M6*12	6	
13	89-1543-080002	Mini Hexagonal Nut (SW) M8	2	
14	89-2511-000140	Snap Ring (S14)	1	
15	0256-01000	Transmission ASSY		

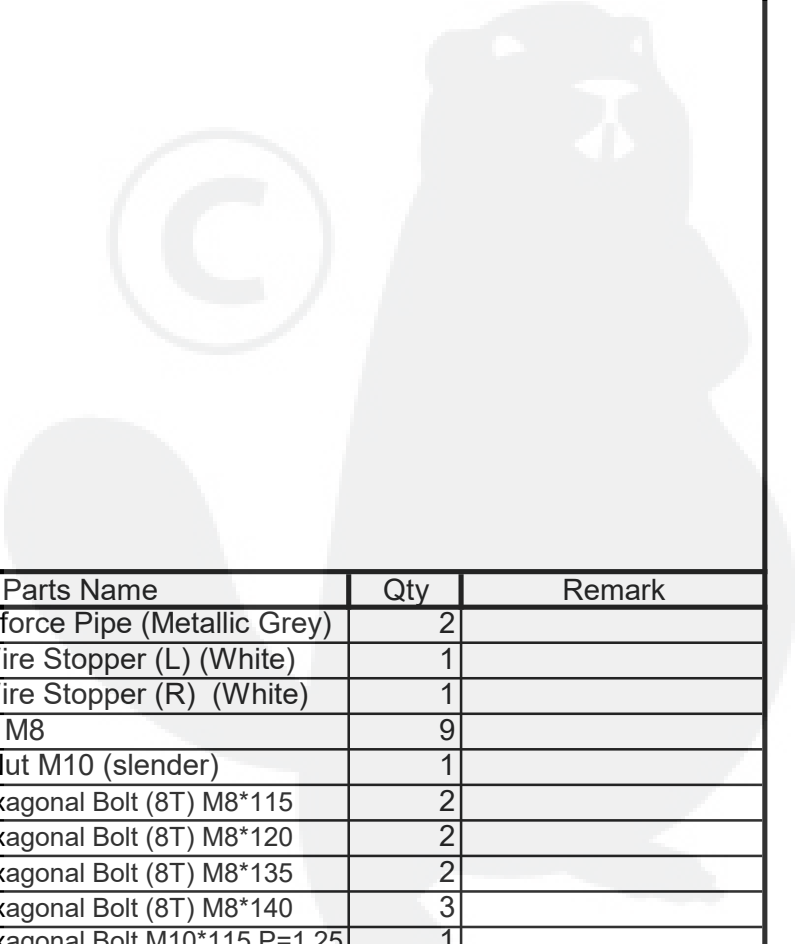
Transmission 2/6

Ref.	Parts No.	Parts Name	Qty	Remark
1	80-1565-159-0H	Shaft BB Reinforce Pipe (Metallic Grey)	2	
2	80-1565-197-01	Side Clutch Wire Stopper (L) (White)	1	
3	80-1614-198-11	Side Clutch Wire Stopper (R) (White)	1	
4	83-1484-255-00	Lock Nut ZUF M8	9	
5	83-1493-255-00	Flange Lock Nut M10 (slender)	1	
6	89-1253-081153	Flange Mini Hexagonal Bolt (8T) M8*115	2	
7	89-1253-081203	Flange Mini Hexagonal Bolt (8T) M8*120	2	
8	89-1253-081353	Flange Mini Hexagonal Bolt (8T) M8*135	2	
9	89-1253-081403	Flange Mini Hexagonal Bolt (8T) M8*140	3	
10	89-1254-101153	Flange Mini Hexagonal Bolt M10*115 P=1.25	1	

10/22

Transmission 3/6

Ref.	Parts No.	Parts Name	Qty	Remark
1	80-1415-114-00	Side Clutch Fork	1	
2	80-1425-112-00	Driving Clutch Fork Shaft	1	
3	80-1565-156-0H	Shaft BB Case (R) (Metallic Grey)	1	
4	0285-00200	Transmission Case (R)	1	
5	0297-08000	Oil Seal AP 30.55.16	1	
6	83-1020-349-00	Copper Packing 10.5*18*1.6	1	
7	83-1415-127-00	Seal Bolt (SW) M8*20	4	
8	83-1415-671-00	Blind Cover 22	1	
9	83-1415-672-00	Blind Cover 30	1	
10	83-1517-685-00	Oil Cap 20	1	
11	89-1252-100123	Flange Mini Hexagonal Bolt M10*12 (slender)	1	
12	89-2111-030020	Spring Pin 3*20	1	
13	89-2111-050020	Spring Pin 5*20	1	
14	89-2512-000550	Snap Ring (R55)	1	
15	89-3111-060064	Bearing 6006	1	
16	89-5121-122207	Oil Seal UE 12.22.7	1	
17	89-5121-153007	Oil Seal UE 15.30.7	1	

11/22

Transmission 4/6

Ref.	Parts No.	Parts Name	Qty	Remark
1	80-1032-140-00	Side Clutch Shaft	1	
2	80-1032-141-00	Side Clutch Gear 14T	2	
3	80-1310-150-10	Shaft Pin	1	
4	80-1575-129-10	2nd Shaft Gear 24T	1	
5	80-1575-142-00	Side Clutch Gear 38T	1	
6	80-1575-162-00	Side Clutch Spring	2	
7	80-1920-130-00	Collar A	1	
8	0223-02500	Collar 6L	1	
9	0251-01610	3rd Shaft Gear 22T	1	
10	0256-00100	Axle CMP	1	
11	0282-00500	2nd Shaft Gear 18T	1	
12	0282-00600	3rd Shaft Gear 28T	1	
13	83-1633-362-10	Thrust Washer 15*30*1.2	2	
14	83-1830-368-00	Thrust Washer 18*26*1.0	4	
15	89-2511-000150	Snap Ring (S15)	2	
16	89-2511-000200	Snap Ring (S20)	2	
17	89-3111-062024	Bearing 6202	4	

12/22

Transmission 5/6

Ref.	Parts No.	Parts Name	Qty	Remark
1	80-1575-109-00	Swing Arm	1	
2	0223-00400	Shift Fork Shaft	1	
3	0223-00600	1st Shaft Gear 20T	1	
4	0223-00700	1st Shaft Shift Gear 14T	1	
5	0223-00800	2nd Shaft	1	
6	0223-01200	Back Gear CMP	1	
7	0223-01400	3rd Shaft	1	
8	0223-02400	Collar 11L	1	
9	0251-00300	Shift Folk	1	
10	0251-01100	Trasmission 1st Shaft	1	
11	0251-01300	2nd Shaft Gear 32T	1	
12	0251-02100	3rd Shaft Gear 14T CMP	1	
13	0282-00400	Spring	1	
14	83-1310-371-00	Thrust Washer 20*30*1.0	2	
15	83-1830-368-00	Thrust Washer 18*26*1.0	2	
16	89-2120-200202	Split Pin 2*20	1	
17	89-2511-000160	Snap Ring (S16)	1	
18	89-3111-062024	Bearing 6202	4	
19	89-3410-075000	Steel Ball 7.5	1	
20	89-3510-012200	DU Bush 12.20	1	
21	89-5221-009000	O Ring P9	1	

13/22

Transmission 6/6

Ref.	Parts No.	Parts Name	Qty	Remark
1	80-1415-114-00	Side Clutch Fork	1	
2	80-1425-112-00	Driving Clutch Folk Shaft	1	
3	80-1565-155-0H	Shaft BB Case (L) (Metallic Grey)	1	
4	0251-00110	Transmission Case (L)	1	
5	0256-00100	Axle CMP	1	
6	0297-08000	Oil Seal AP 30.55.16	1	
7	83-1415-127-00	Seal Bolt (SW) M8*20	4	
8	83-1415-671-00	Blind Cover 22	1	
9	83-1415-672-00	Blind Cover 30	1	
10	83-1517-685-00	Oil Cap 20	1	
11	89-1251-060102	Flange Hexagonal Bolt M6*10	1	
12	89-2111-030020	Spring Pin 3*20	1	
13	89-2111-050020	Spring Pin 5*20	1	
14	89-2512-000550	Snap Ring (R55)	1	
15	89-3111-060064	Bearing 6006	1	
16	89-5121-122207	Oil Seal UE 12.22.7	1	
17	89-5121-153007	Oil Seal UE 15.30.7	1	
18	89-5230-060000	Seal Washer 6	1	

Rotary Cover 1/5

Ref.	Parts No.	Parts Name	Qty	Remark
1	0334-75100	Lever Grip (Black) 10	1	
2	0256-6010G	Safety Cover (Green)	1	
3	0256-60400	Rear Flapper	1	
4	0256-60601	Flapper Holder (White)	1	
5	0285-6120G	Height Adjusting Bolt Receiver CMP (Green)	1	
6	0285-62400	Height Adjusting Bolt CMP	1	
7	89-1581-060042	Flange Cap Nut M6	4	
8	83-1713-166-00	Round Headed Pin 10*80	1	
9	84-1723-739-00	Cutting Height Adjusting Handle	1	
10	89-1137-060152	Hexagonal Bolt (PW) M6*15	4	
11	89-1211-080252	Mini Hexagonal Bolt M8*25	2	
12	89-1611-080042	Mini Hexagonal Nut M8	2	
13	89-1711-100002	Flat Washer 10*18*1.6	2	
14	89-1714-120002	Flat Washer 12	1	
15	89-2111-050022	Spring Pin 5*22	1	
16	89-2131-100002	Snap Pin 10	1	
17	89-2181-100502	Flat Head Pin 10*50	1	

Rotary Cover 2/5

Ref.	Parts No.	Parts Name	Qty	Remark
1	80-1610-714-00	Front Arm Setting Shaft	2	
2	80-1614-725-2G	Front Wheel Fork (Green)	2	
3	80-1614-726-00	Front Wheel Collar	2	
4	0256-6030G	Front Arm CMP (Green)	1	
5	0256-6050G	Front Bumper (Green)	1	
6	0256-60700	Dust Cover	2	
7	0285-73100	Front Wheel	2	
8	83-1415-975-00	Grease Nipple M6	2	
9	83-1610-192-00	Hexagonal Nut (slender) M12 P=1.25	2	
10	83-1783-376-00	Thrust Washer 25*34*1.0	2	
11	84-1783-791-00	Grease Nipple Bolt M14	2	
12	89-1211-100952	Mini Hexagonal Bolt M10*95	2	
13	89-1253-080202	Flange Mini Hexagonal Bolt (8T) M8*20	4	
14	89-1543-080002	Mini Hexagonal Nut (SW) M8	4	
15	89-1543-100002	Mini Hexagonal Nut (SW) M10	2	
16	89-1714-120002	Flat Washer 12	2	
17	89-1750-120002	Spring Washer 12	2	
18	89-1750-140002	Spring Washer 14	2	
19	89-3370-051105	Thrust Bearing 51105	2	

Rotary Cover 3/5

Ref.	Parts No.	Parts Name	Qty	Remark
1	80-1182-827-00	Tension Pulling Bolt	1	
2	80-1614-315-00	Return Spring	1	
3	80-1614-694-11	Blade Belt Cover (White)	1	
4	80-1675-357-00	Thrust Washer 16*23*2.3	2	
5	0211-63201	Front Tension Arm CMP (White)	1	
6	0256-50201	Front Cover CMP (White)	1	
7	0256-60200	Front Flapper	1	
8	0256-60601	Flapper Holder (White)	1	
9	0285-66100	Rubber L30	2	
10	83-1032-765-00	Tension Pulley	1	
11	89-1581-060042	Flange Cap Nut M6	4	
12	89-1137-060152	Hexagonal Bolt (PW) M6*15	4	
13	89-1233-080162	Mini Hexagonal Bolt (PWSW) M8*16	2	
14	89-1611-080042	Mini Hexagonal Nut M8	2	
15	89-2511-000170	Snap Ring (S17)	1	
16	89-2512-000400	Snap Ring (R40)	1	
17	89-2521-000120	E Type Ring 12	2	
18	89-2521-000150	E Type Ring 15	1	
19	89-3115-062034	Bearing 6203 2RS	1	
20	89-6123-003900	V Belt LB-39	1	

Rotary Cover 4/5

Ref.	Parts No.	Parts Name	Qty	Remark
1	80-1417-371-01	Knife Brake (White)	1	
2	80-1614-373-20	Knife Brake Spring	1	
3	80-1614-636-00	Supporter Pulley	2	
4	0212-72100	Hexagonal Bolt(8T) M10*25(Meck)	2	
5	0256-4010G	Supporter Pipe CMP (Green)	1	
6	0256-40200	Supporter Shaft	1	
7	0256-40501	Knife Pulley (White)	1	
8	83-1610-125-00	Hexagonal Bolt (8T) M10*35	1	
9	83-1610-321-00	Washer 10*36*4.5	2	
10	83-1610-322-00	Washer 10*36*6	1	
11	89-1213-080182	Mini Hexagonal Bolt (8T) M8*18	4	
12	89-1750-080002	Spring Washer 8	4	
13	89-1750-100002	Spring Washer 10	3	
14	89-2151-050350	Key 5*35 (half round)	2	
15	89-2151-070300	Key 7*30 (half round)	1	
16	89-2521-000150	E Type Ring 15	1	
17	89-3115-060044	Bearing 6004 2RS	2	

18/22

Rotary Cover 5/5

Ref.	Parts No.	Parts Name	Qty	Remark
1	80-1610-804-01	BB Case (White)	2	
2	80-1610-821-00	Hammer Knife Blade	32	
3	80-1612-813-01	Dust Cover (White)	2	
4	80-1614-705-00	Flat Head Bolt M8*18	6	
5	80-1614-810-00	BB Case Cover	1	
6	0256-5010G	Rotary Cover CMP (Green)	1	
7	0256-51000	Knife Drum ASSY	1	
8	0285-6040G	Receiver, Knfie Shaft & BB Case (Green)	1	
9	83-1610-124-00	Hexagonal Bolt (8T) M10*25 (left screw)	1	
10	83-1610-321-00	Washer 10*36*4.5	1	
11	83-1610-835-00	Knife Setting Bolt Set	16	
12	89-1253-080162	Flange Mini Hexagonal Bolt (8T) M8*16	8	
13	89-1671-080042	Mini Cap Nut M8	6	
14	89-1750-080002	Spring Washer 8	14	
15	89-1812-100002	Toothed washer (inside) 10	1	
16	89-2512-000620	Snap Ring (R62)	2	
17	89-3115-062064	Bearing 6206 2RS	2	
18	0285-6010G	Knife Shaft BB Case Set (Green)	2	Include 1,3,8,12,14

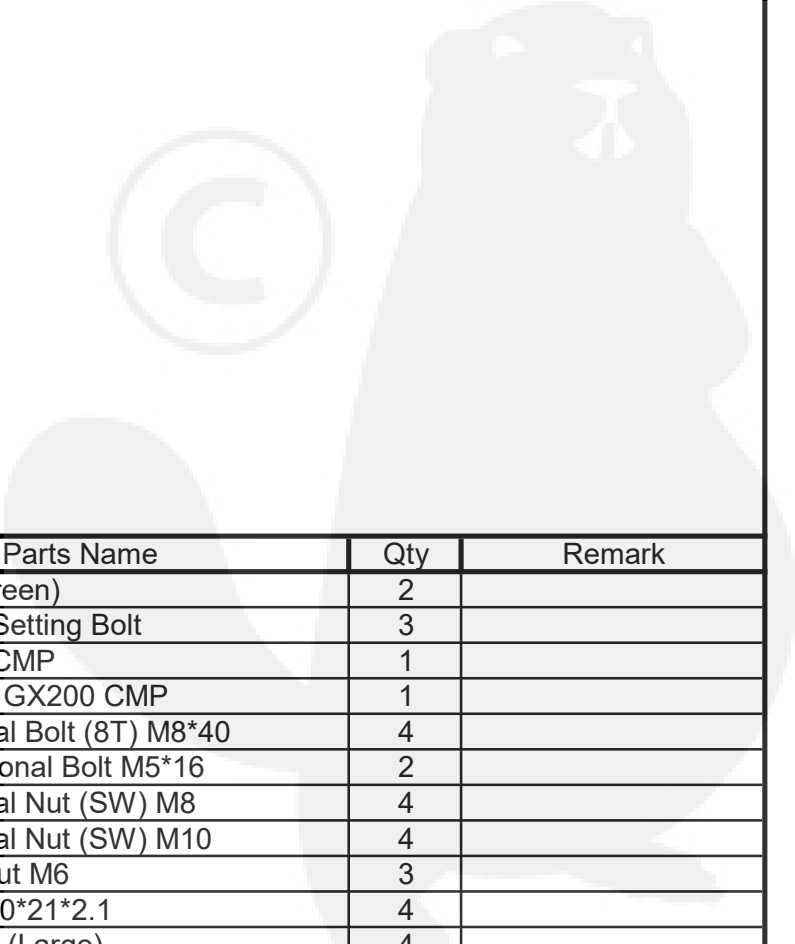

Ref.	Parts No.	Parts Name	Qty	Remark
1	0256-2010G	Free Base (Green)	2	
2	0256-60800	Recoil Cover Setting Bolt	3	
3	0256-60900	Recoil Cover CMP	1	
4	0256-61200	Muffler Guard GX200 CMP	1	
5	89-1213-080402	Mini Hexagonal Bolt (8T) M8*40	4	
6	89-1251-050163	Flange Hexagonal Bolt M5*16	2	
7	89-1543-080002	Mini Hexagonal Nut (SW) M8	4	
8	89-1543-100002	Mini Hexagonal Nut (SW) M10	4	
9	89-1581-060042	Flange Cap Nut M6	3	
10	89-1712-100002	Flat Washer 10*21*2.1	4	
11	89-1713-080002	Flat Washer 8 (Large)	4	

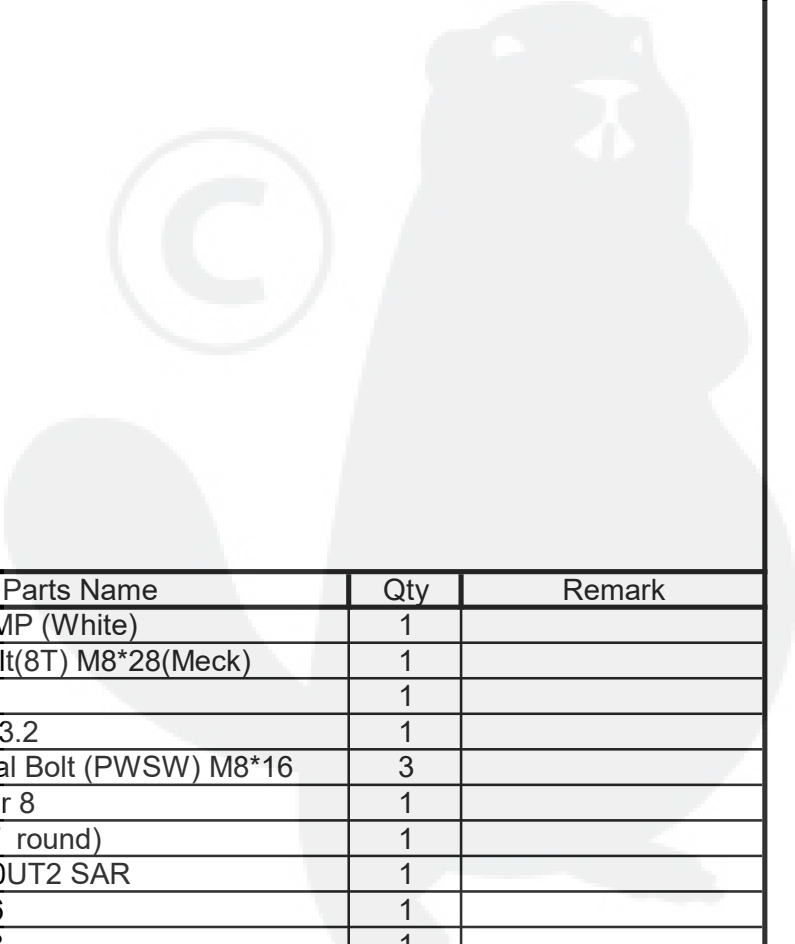

Ref.	Parts No.	Parts Name	Qty	Remark
1	80-1614-561-21	Belt Holder CMP (White)	1	
2	0023-72300	Hexagonal Bolt(8T) M8*28(Meck)	1	
3	0256-4030S	Engine Pulley	1	
4	83-1415-312-00	Washer 8*30*3.2	1	
5	89-1233-080162	Mini Hexagonal Bolt (PWSW) M8*16	3	
6	89-1750-080002	Spring Washer 8	1	
7	89-2151-050350	Key 5*35 (half round)	1	
8	-	Engine GX200UT2 SAR	1	
9	89-6122-004601	V Belt SAR-46	1	
10	89-6123-006301	V Belt SBR-63	1	

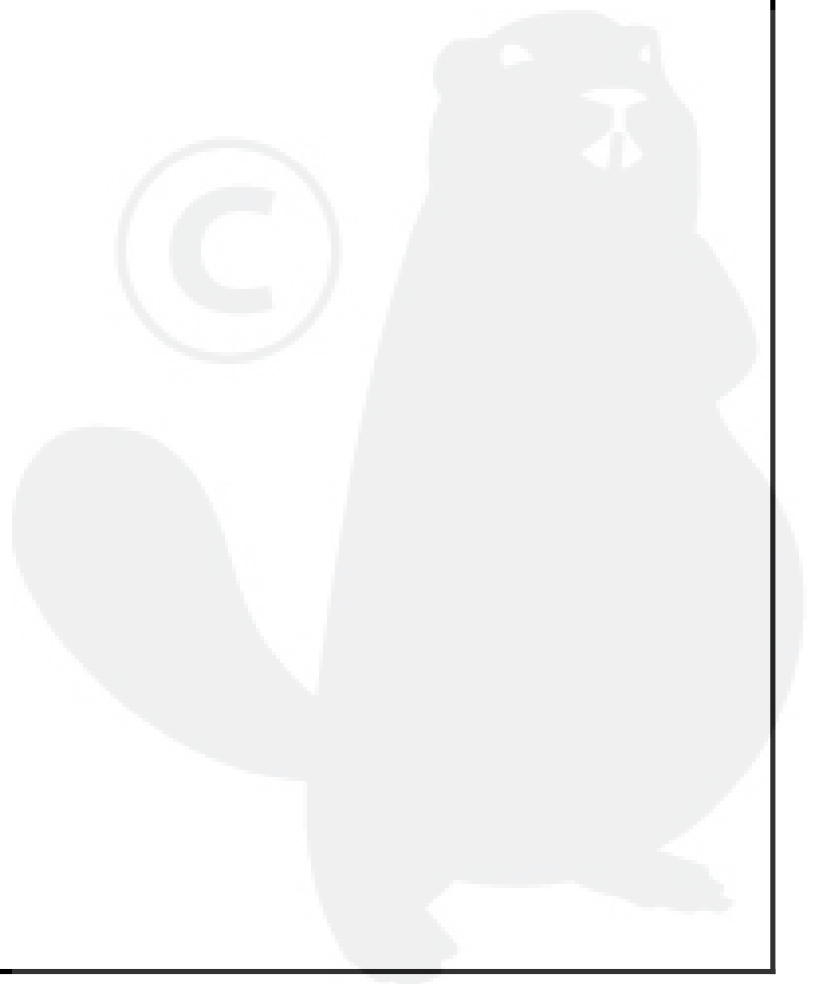

Ref.	Parts No.	Parts Name	Qty	Remark
1	80-1020-932-00	Label, Noise 100db	1	
2	80-1488-928-10	Label, Caution for Belt Involving	2	
3	0223-76100	Label, Caution (Large)	1	
4	0256-71210	Label, Transmission (HR531)	1	
5	0256-71310	Label, Belt size	1	
6	0256-72500	Label, Change	1	
7	0256-77100	Label, Bonnet (HR531)	1	
8	0270-71300	Label, Protection Equipment	1	
9	0270-71400	Attention Label for Slope 15°	1	
10	0304-71500	Label for Left Screw	1	
11	0334-72400	Label, OREC Logo (Large)	1	
12	0334-72500	Label, OREC Logo (Small)	1	
13	0334-72600	Label, Bull Mower	1	
14	0334-72700	Label, Guard Cover	1	
15	0334-76110	Label, Cutting	1	
16	0334-76210	Label, Driving	1	
17	0335-75400	Label, Handle Up/Down	1	
18	0335-75600	Label, Gear Oil	1	
19	83-1613-907-10	Label, Caution for Hand and Leg	4	